

***SEWING MACHINE TABLE
COMFORT 1 (C 1L , C 1XL)***



SYMBOLS



ATTENTION



ASSEMBLY & ADJUSTMENT

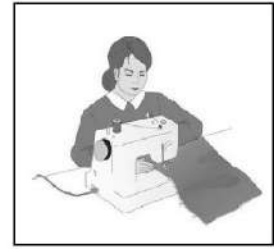

OPERATION



STORAGE

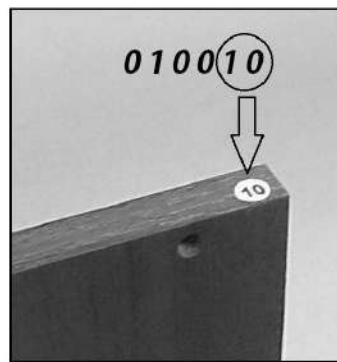

INDICATING MARK

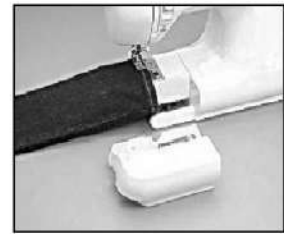

SPECIAL OPERATION

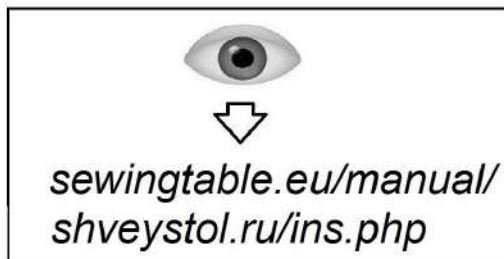



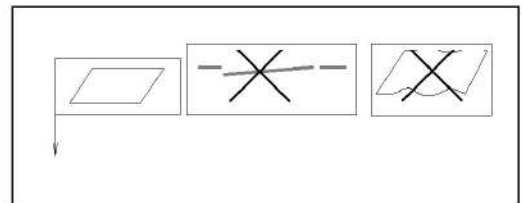



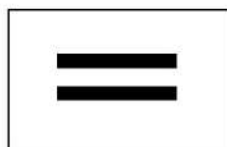

















WATCH



EVEN SURFACE



EQUALITY

010001 1x		010002 1x		010003 1x		010004 1x					
010006 1x		010007 1x		010008 1x		010009 1x					
 <p>020001 2x</p>		 <p>020002 2x</p>		 <p>020003 1x</p>		 <p>020004 1x 020005 1x</p>					
 <p>020006 1x</p>		 <p>020008 1x</p>		 <p>020010 L 660 1x</p>		 <p>020011 1x</p>		 <p>020012 1x</p>			
 <p>030001 3 * 16 24x</p>		 <p>030002 3,5 * 16 8x</p>		 <p>030003 6,2 * 50 8x</p>		 <p>030004 φ5 * 16 4x</p>		 <p>030005 4,2 * 16 10x</p>		 <p>030006 2,9 * 13 4x</p>	
 <p>030007 φ6 2x</p>		 <p>030008 φ4 2x</p>		 <p>030009 M4 * 20 2x</p>		 <p>030010 φ6 4x</p>		 <p>030011 φ15 8x</p>		 <p>030012 φ18 6x</p>	
 <p>030013 L = 35 6x</p>				 <p>030015 φ8 * 30 6x</p>		 <p>030014 φ15 h12 6x</p>		 <p>030033 4,2 * 13 15x</p>			

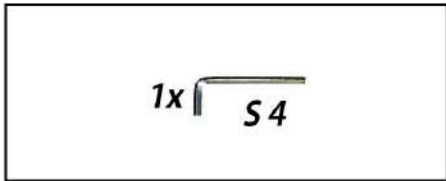
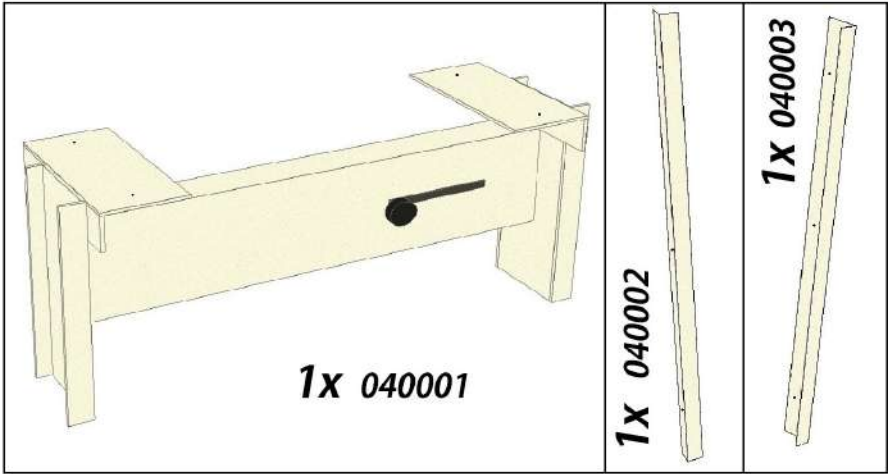

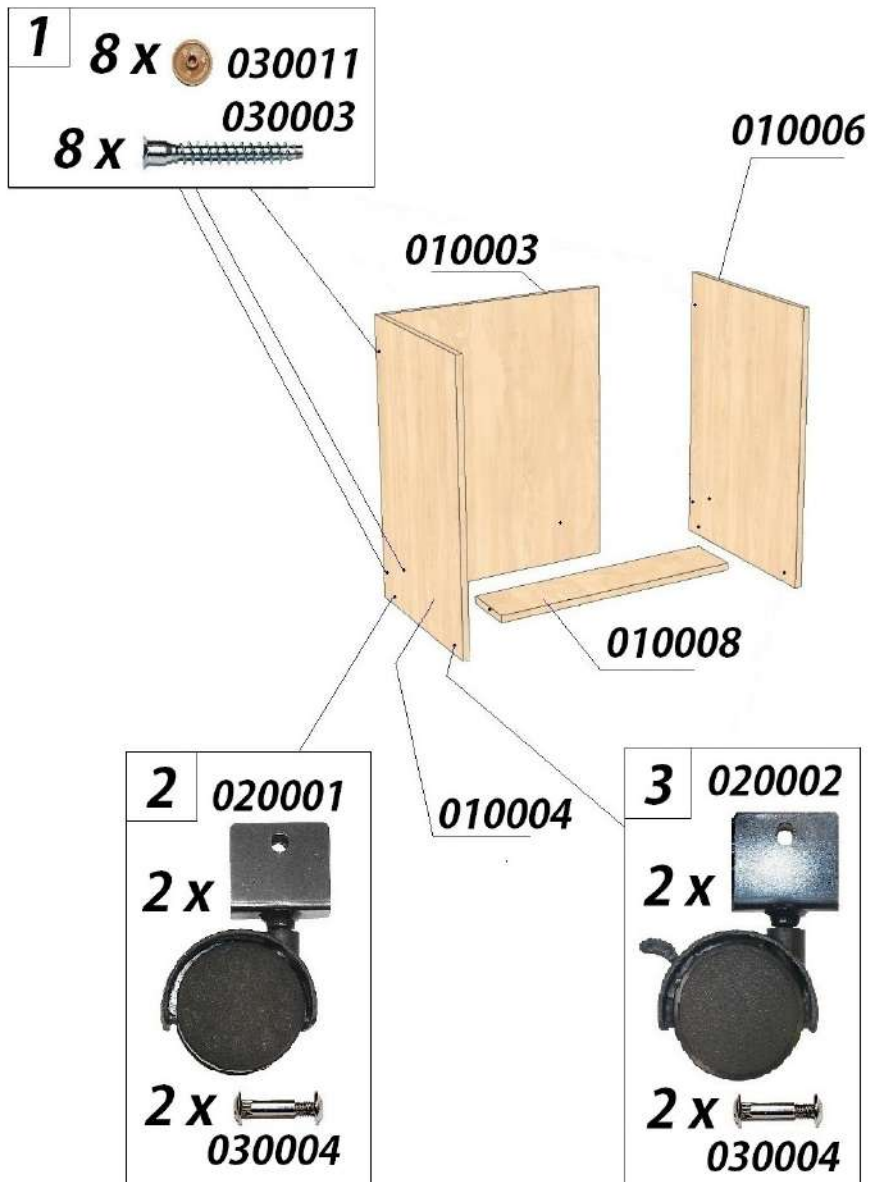

*
Included into table set.

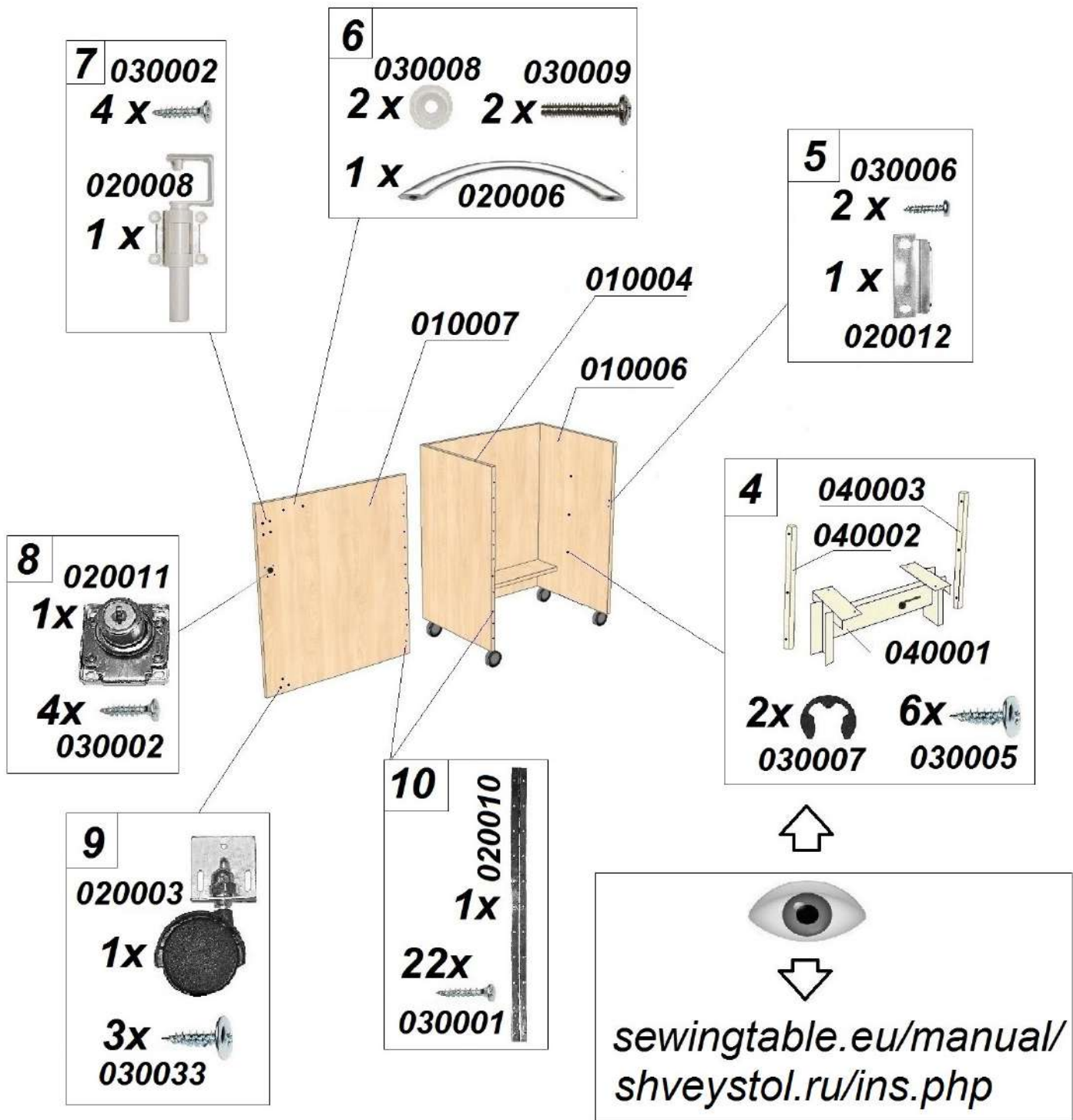

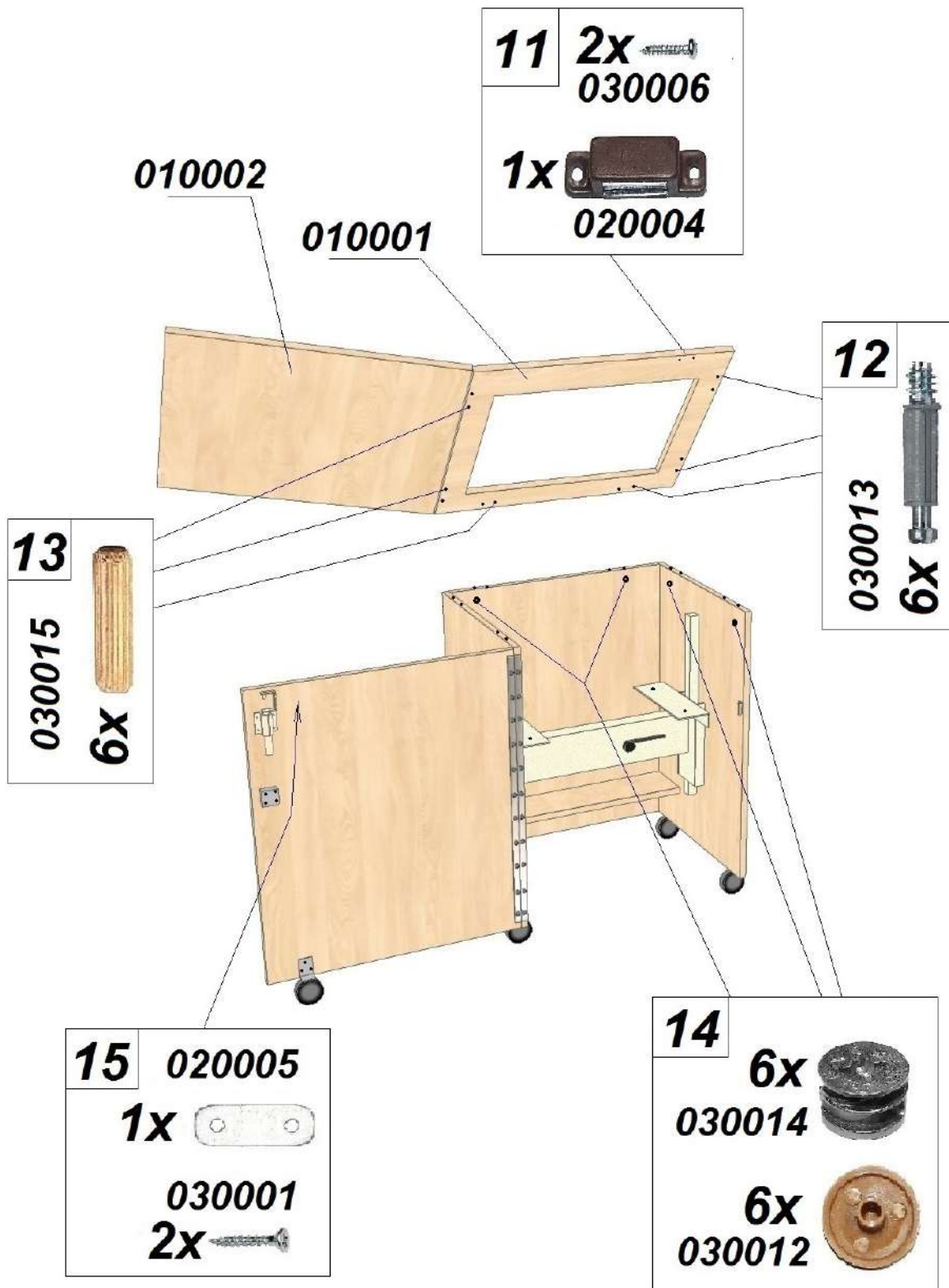

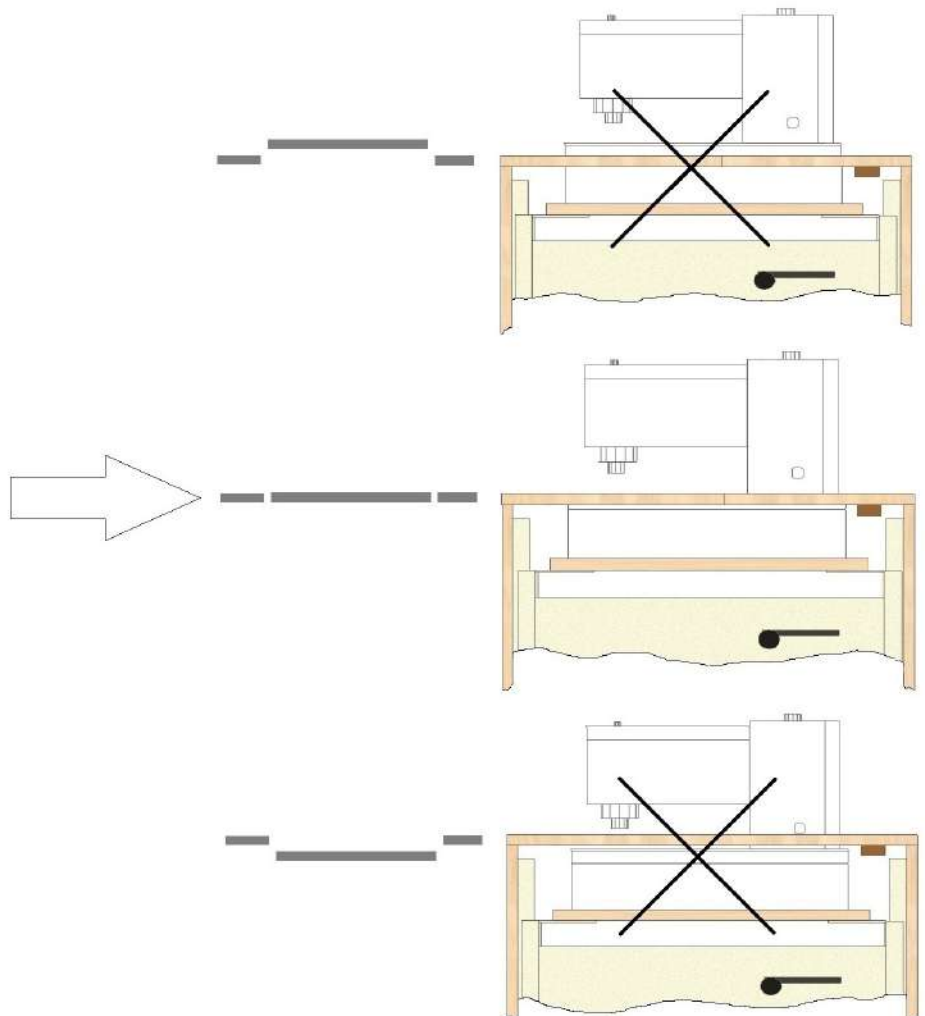
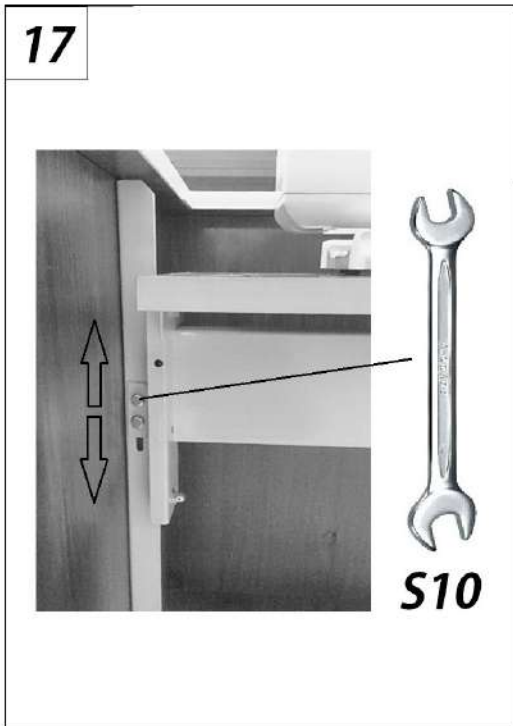
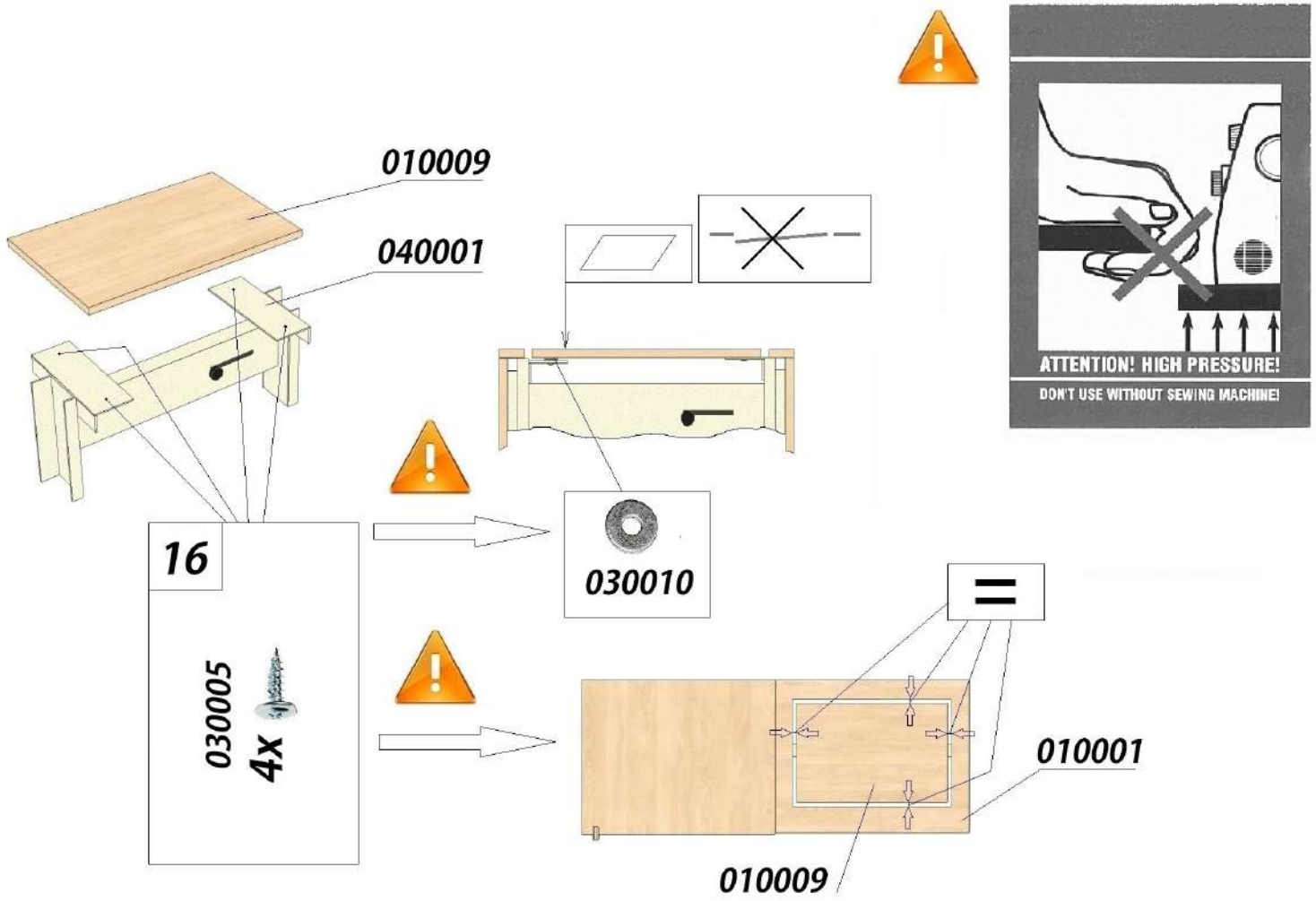

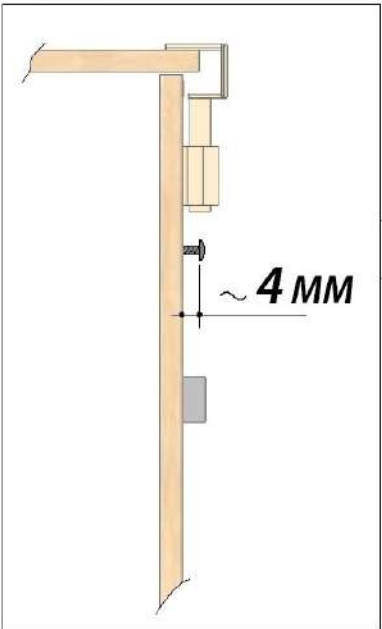

030033

