

***SEWING MACHINE TABLE***  
***COMFORT 8***

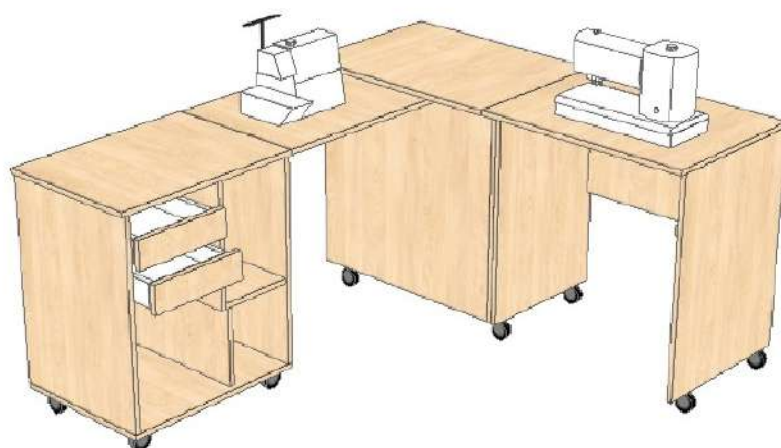

# ***SYMBOLS***



***ATTENTION***



***ASSEMBLY & ADJUSTMENT***



***OPERATION***

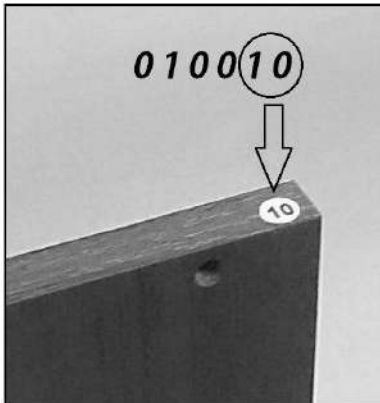



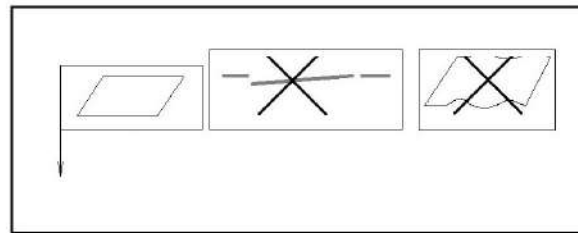

***INDICATING MARK***



***EVEN SURFACE***

010001 1x	010002 1x	010003 1x	010004 1x
010006 1x	010007 1x	010011 2x	010012 2x
010013 2x	010023 1x	010024 1x	010025 1x
010026 1x	010027 1x	010029 1x	010030 1x
010031 1x	010033 1x		

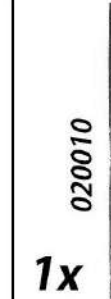
 <b>020001</b> <b>2x</b>	 <b>020002</b> <b>2x</b>	 <b>020003</b> <b>1x</b>	 <b>020004 1x</b>  <b>020005 1x</b>
---	---	---	--





 <b>020006</b> <b>1x</b>	 <b>020008</b> <b>1x</b>	 <b>020009</b> <b>1x</b> L300	 <b>020010</b> <b>1x</b> L660	 <b>020011</b> <b>1x</b>	 <b>020012</b> <b>1x</b>
--	--	--	--	---	---

<b>2x</b> <b>020013 CR</b> 	<b>2x</b> <b>020013 CL</b> 
---	--



<b>2x</b> <b>020015 DR</b> 	<b>2x</b> <b>020015 DL</b> 
---	--

<b>020021</b>  <b>4x</b>	<b>2 x 020022</b> 
---	--

<b>030001</b>  3 * 16 <b>46x</b>	<b>030002</b>  3,5 * 16 <b>16x</b>	<b>030003</b>  6,2 * 50 <b>22x</b>	<b>030004</b>  φ5 * 16 <b>4x</b>	<b>030033</b>  4,2 * 13 <b>3x</b>	<b>030006</b>  2,9 * 13 <b>4x</b>
--	--	--	--	---	---



<b>030008</b>  φ4 <b>2x</b>	<b>030009</b>  M4 * 20 <b>2x</b>	<b>030011</b>  φ15 <b>22x</b>	<b>030012</b>  φ18 <b>12x</b>	<b>030013</b>  L = 35 <b>12x</b>	<b>030014</b>  φ15 h12 <b>12x</b>
---	--	---	---	--	---

<b>030015</b>  φ8 * 30 <b>16x</b>	<b>030016</b>  φ8 * 30 <b>4x</b>	<b>030017</b>  φ15 h10 <b>4x</b>	<b>030022</b>  M 10 <b>4x</b>	<b>030023</b>  φ10 <b>4x</b>	<b>030024</b>  5 * 50 <b>2x</b>
---	--	--	---	--	---

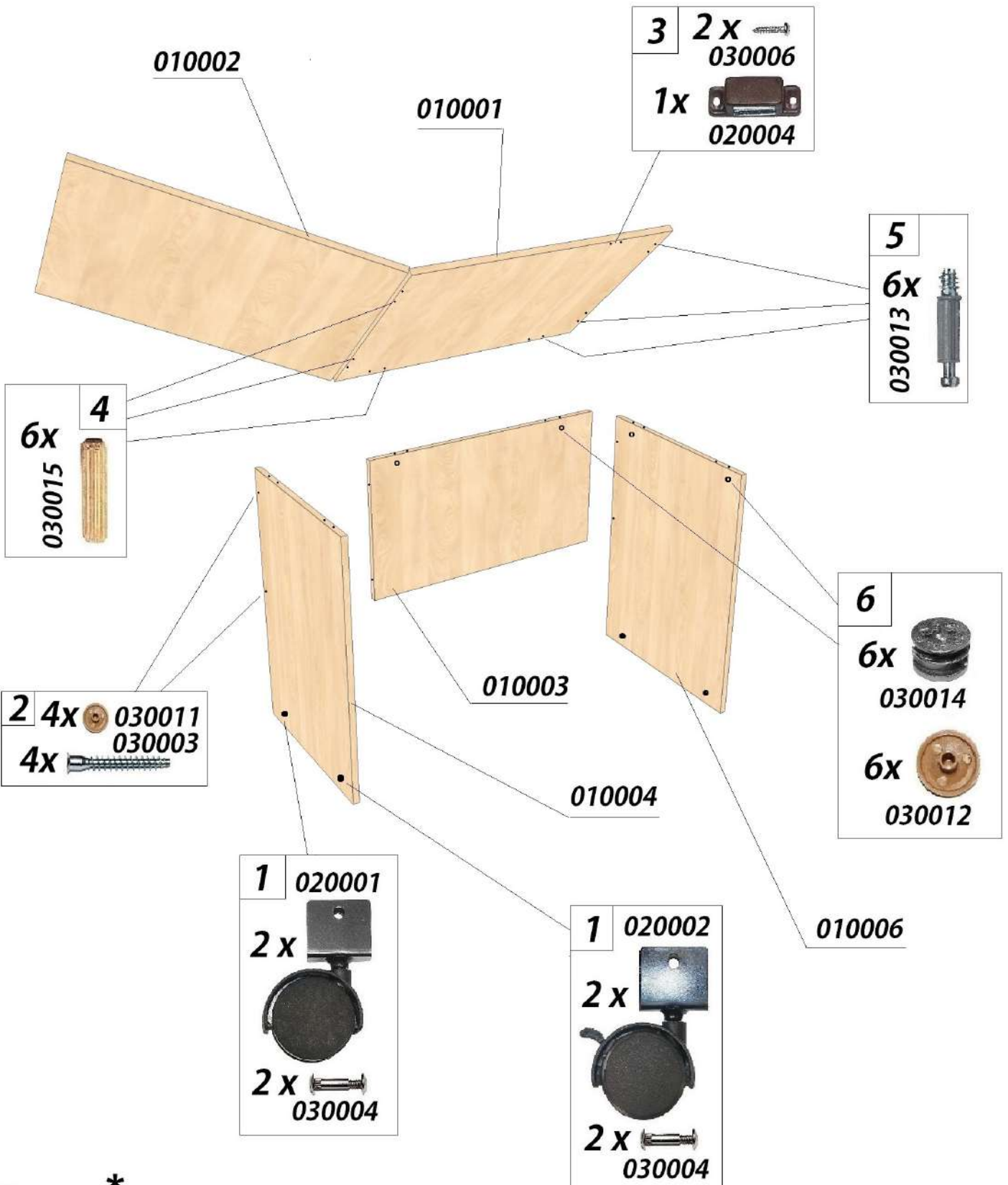
<b>1x</b>  <b>S3</b>	<b>1x</b>  <b>S4</b>	 <b>030031</b> φ10 s2,5 <b>4x</b>
---	---	---





**12** 030002  
**4x**   
 020008  
**1x** 

**13** 020005  
**1x**   
 030001  
**2x** 

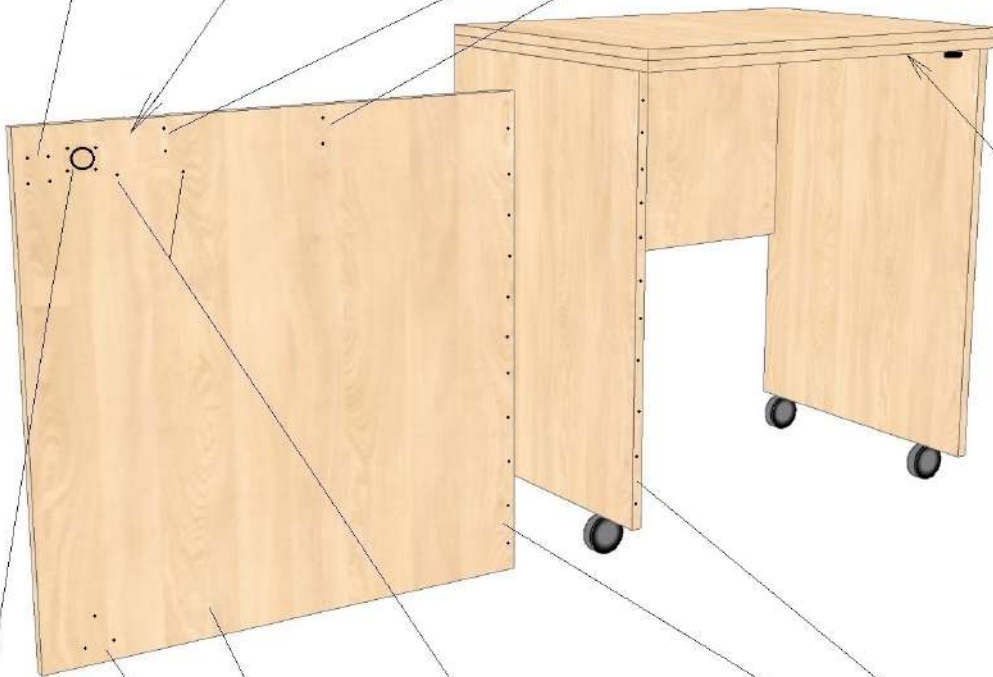

**9**   
**2x**  
 020022  
**4x**   
 030001





**14**  
 030006  
**2x**   
**1x**   
 020012

010007

**10**  
**1x** 020010  
**22x**   
 030001

**8** 020011  
**1x**   
**4x**   
 030002

**7**   
 020003  
**1x**   
**3x**   
 030033

**11**  
 030008 030009  
**2x**   
**1x**   
 020006



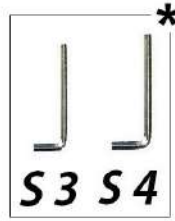

18 6x 030011  
6x 030003

010030

15

030002  
4x

2x 020013 CR

010027

16

030003  
4x  
030011  
4x

010024

17

030003  
6x  
030011  
6x

010025

010033

010031

010026

19

4x 030022

4x 030031

4x 030023

4x 020021

15

020013 CL  
2x

030002  
4x



6

\* Included into table set.

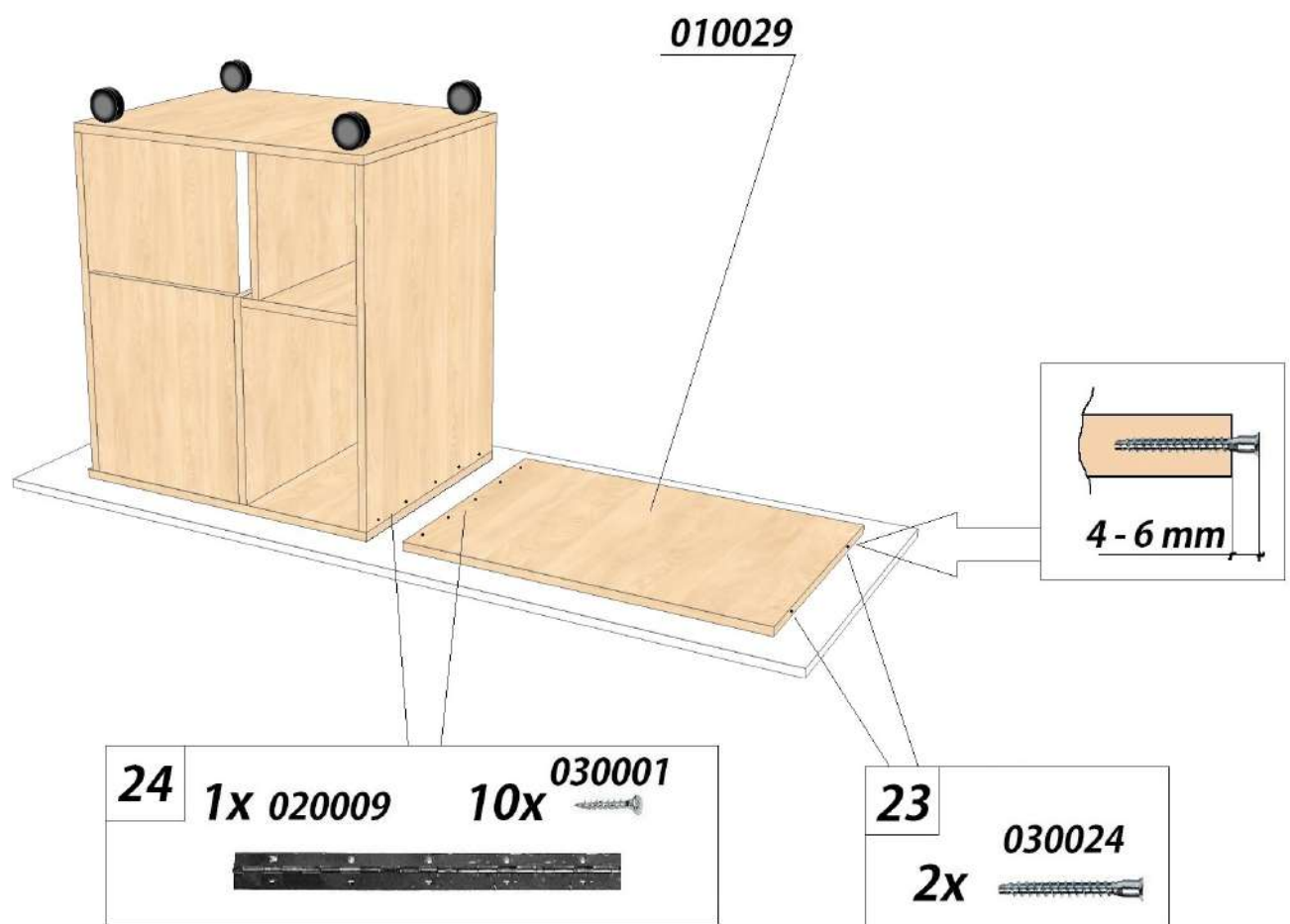
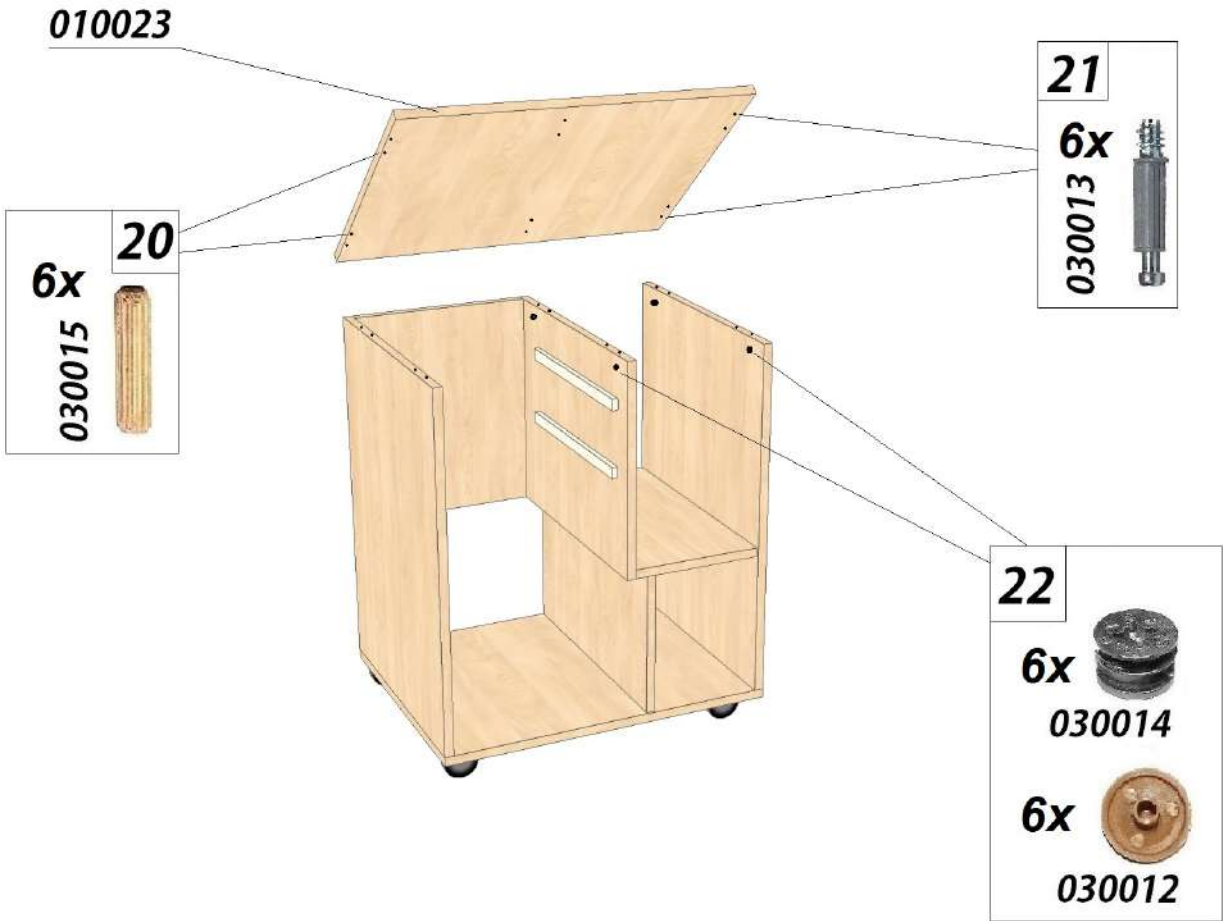

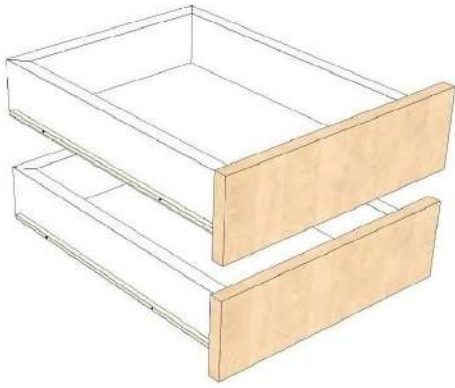

**28**

4x 030001

2x 020015 DR

030016 **26**

4x

**27**

4x 030017

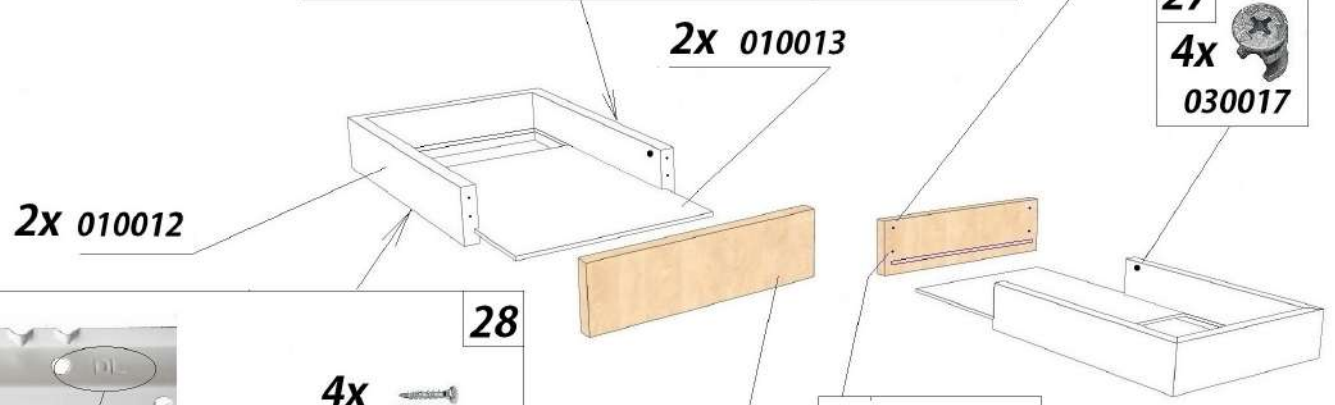

**28**

2x 020015 DL

4x 030001

**25**

4x 030015



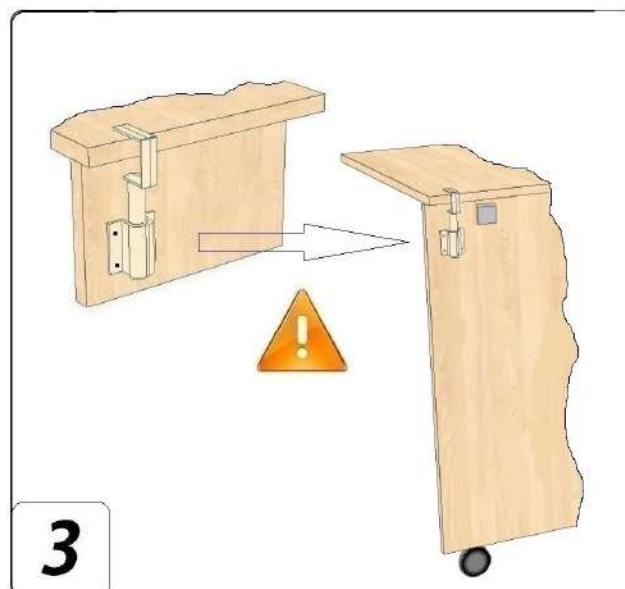
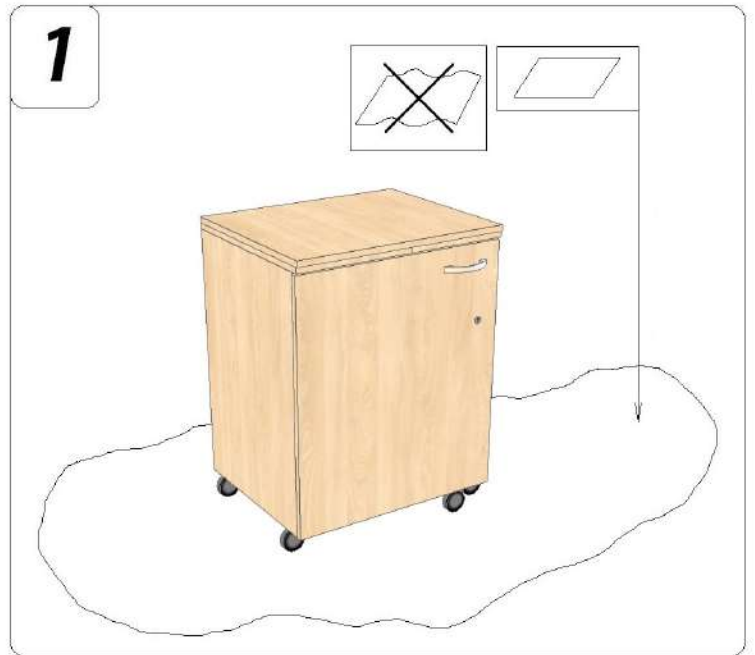

4

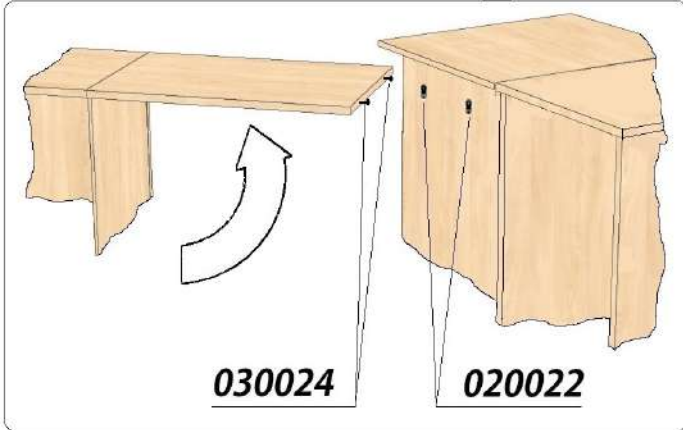
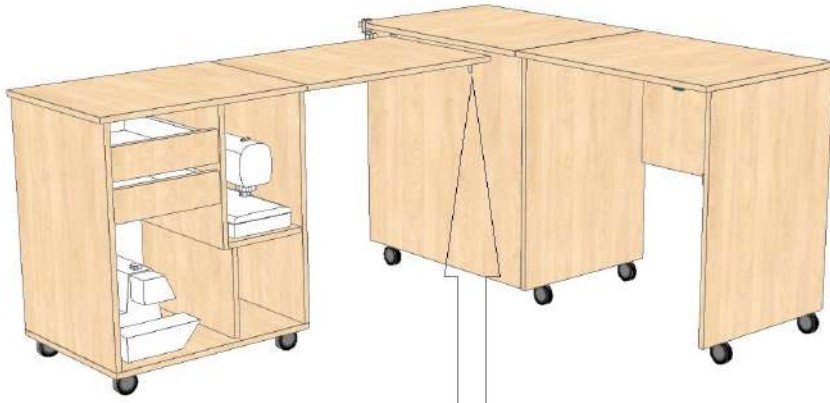

5

