

SEWING MACHINE TABLE
COMFORT JUNIOR

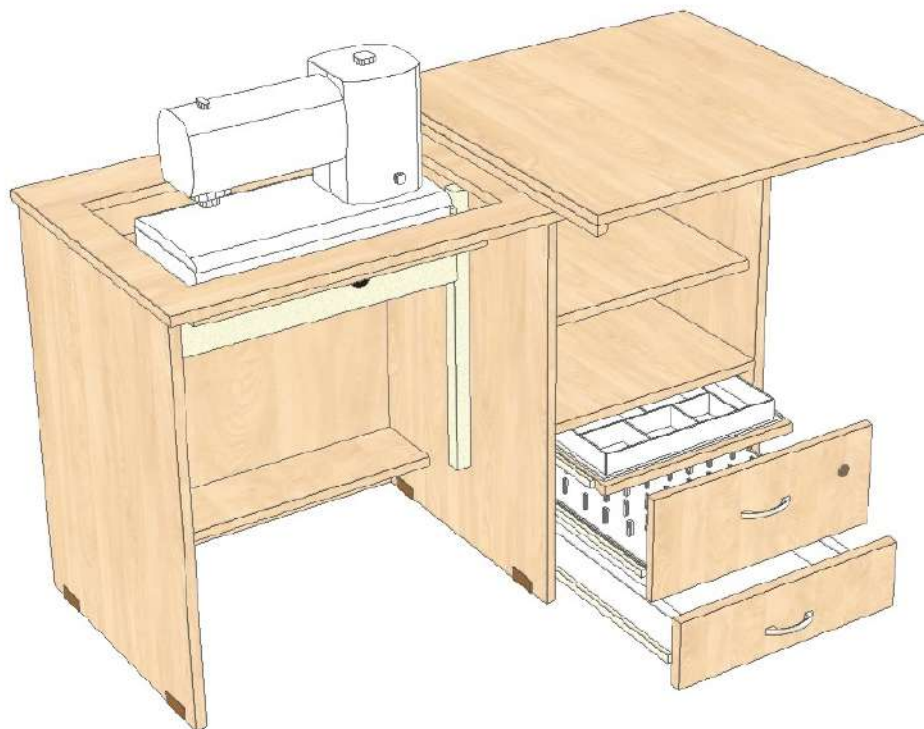

SYMBOLS



ATTENTION



ASSEMBLY & ADJUSTMENT



OPERATION



STORAGE

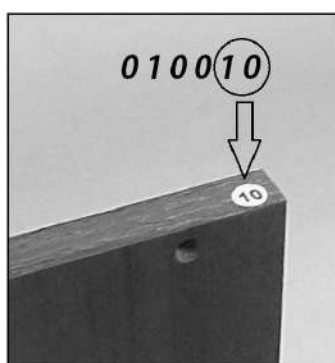

INDICATING MARK



SPECIAL OPERATION

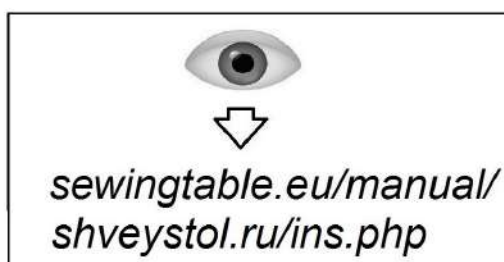

WATCH

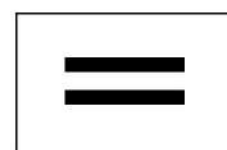



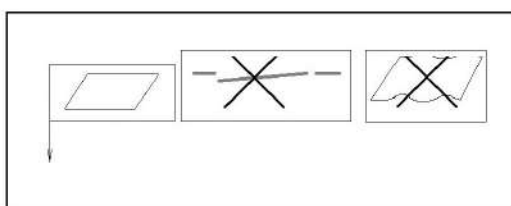













EQUALITY



EVEN SURFACE

010001 1x	010003 1x	010004 1x	010006 1x	010008 1x	010009 1x
010011 1x	010012 1x	010013 1x	010014 1x	010016 1x	010028 2x
010033	010034	010041 1x			

 020006 2x	 020011 1x	 020012 1x	 020020 4x	 020024 6x
 3x 020015 DR		 3x 020015 DL		
 3x 020013 CR		 3x 020013 CL		

 030001 3 * 16 12x	 030002 3,5 * 16 36x	 030003 6,2 * 50 20x		 030005 4,2 * 16 10x	 030006 2,9 * 13 2x
 030007 φ 6 2x	 030008 φ 4 4x	 030009 M4 * 20 4x	 030010 φ 6 4x	 030011 φ 15 18x	 030012 φ 18 9x
 030013 L = 35 9x	 030014 φ 15 h12 9x	 030015 φ 8 * 30 10x	 030016 φ 8 * 30 2x	 030017 φ 15 h10 2x	 030027 M4 * 35 2x

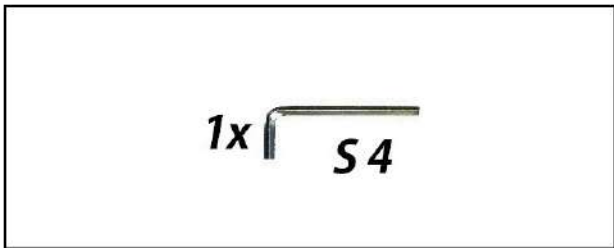
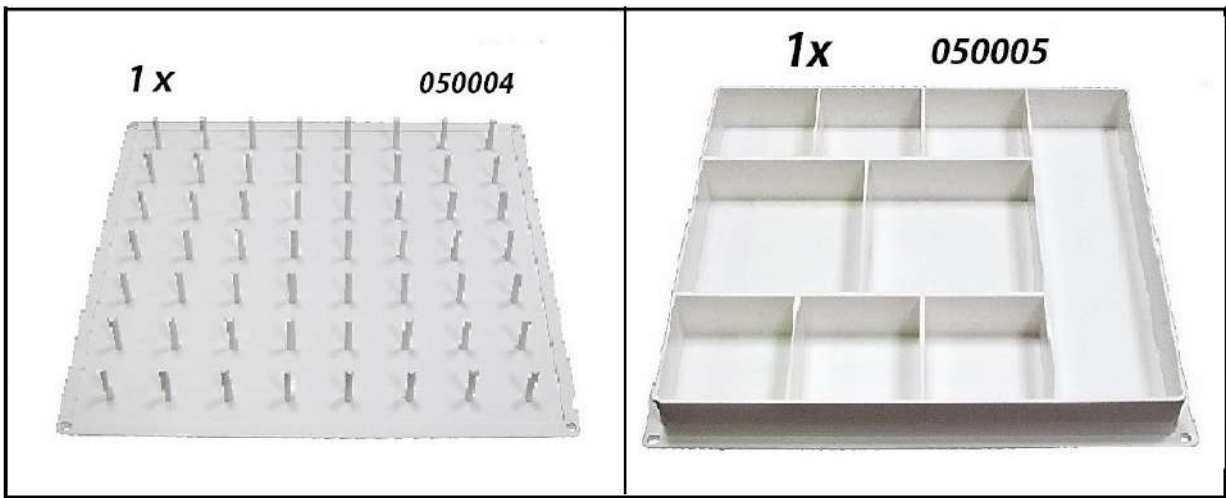
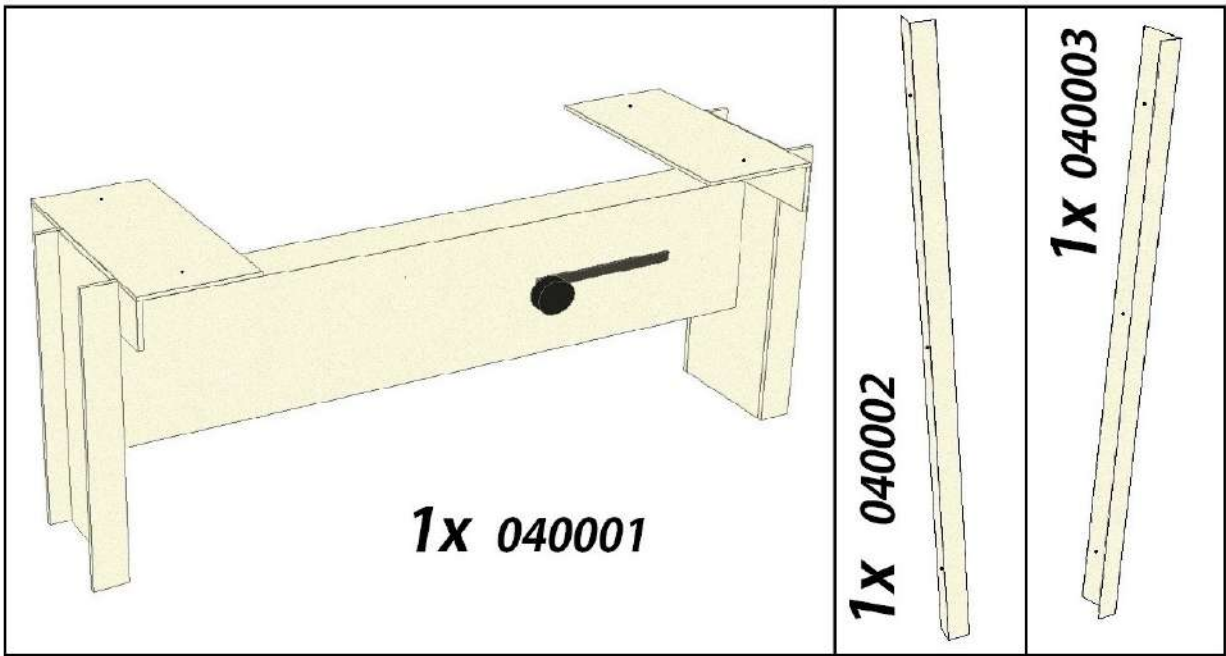

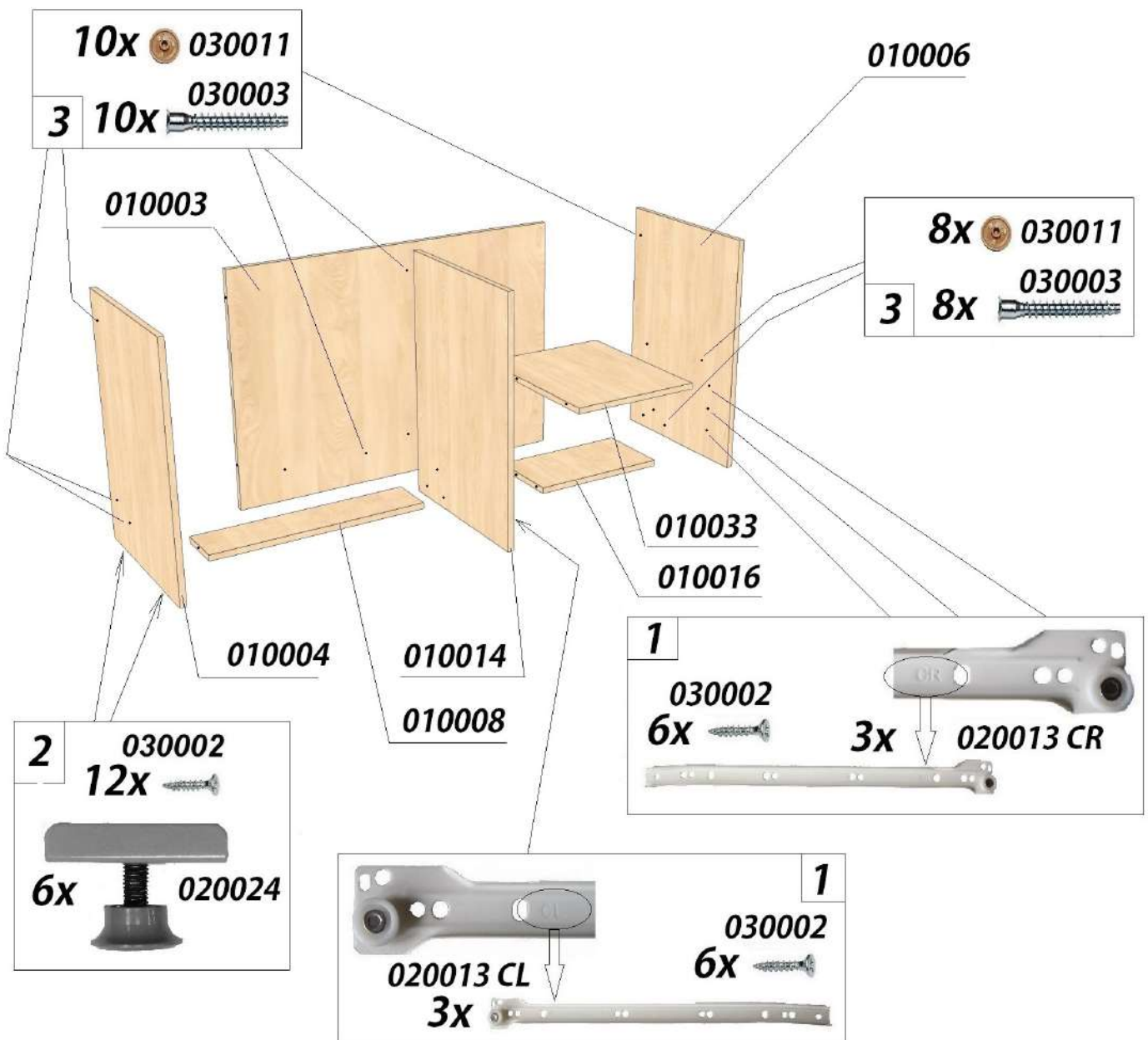

* Included into table set.

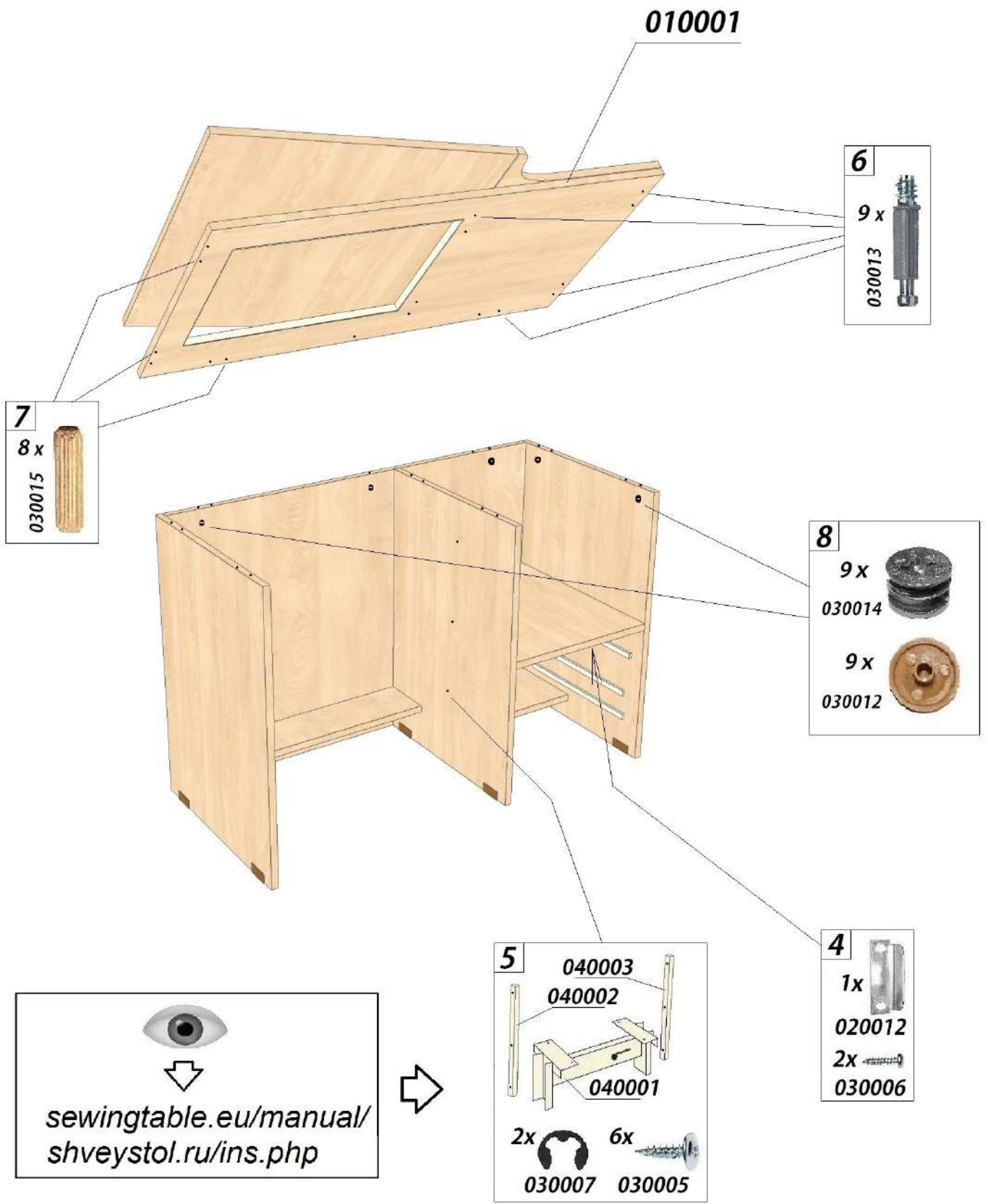

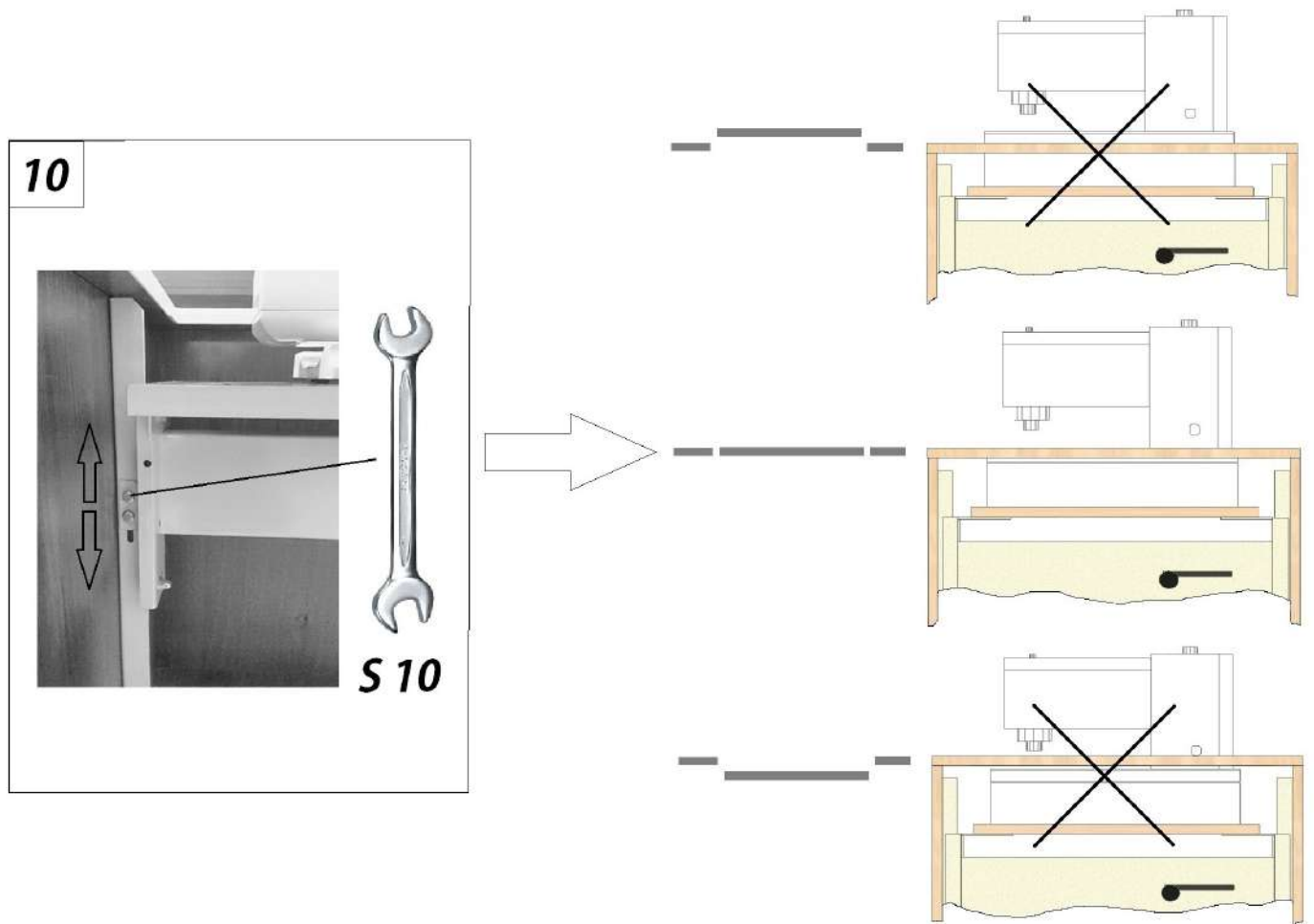
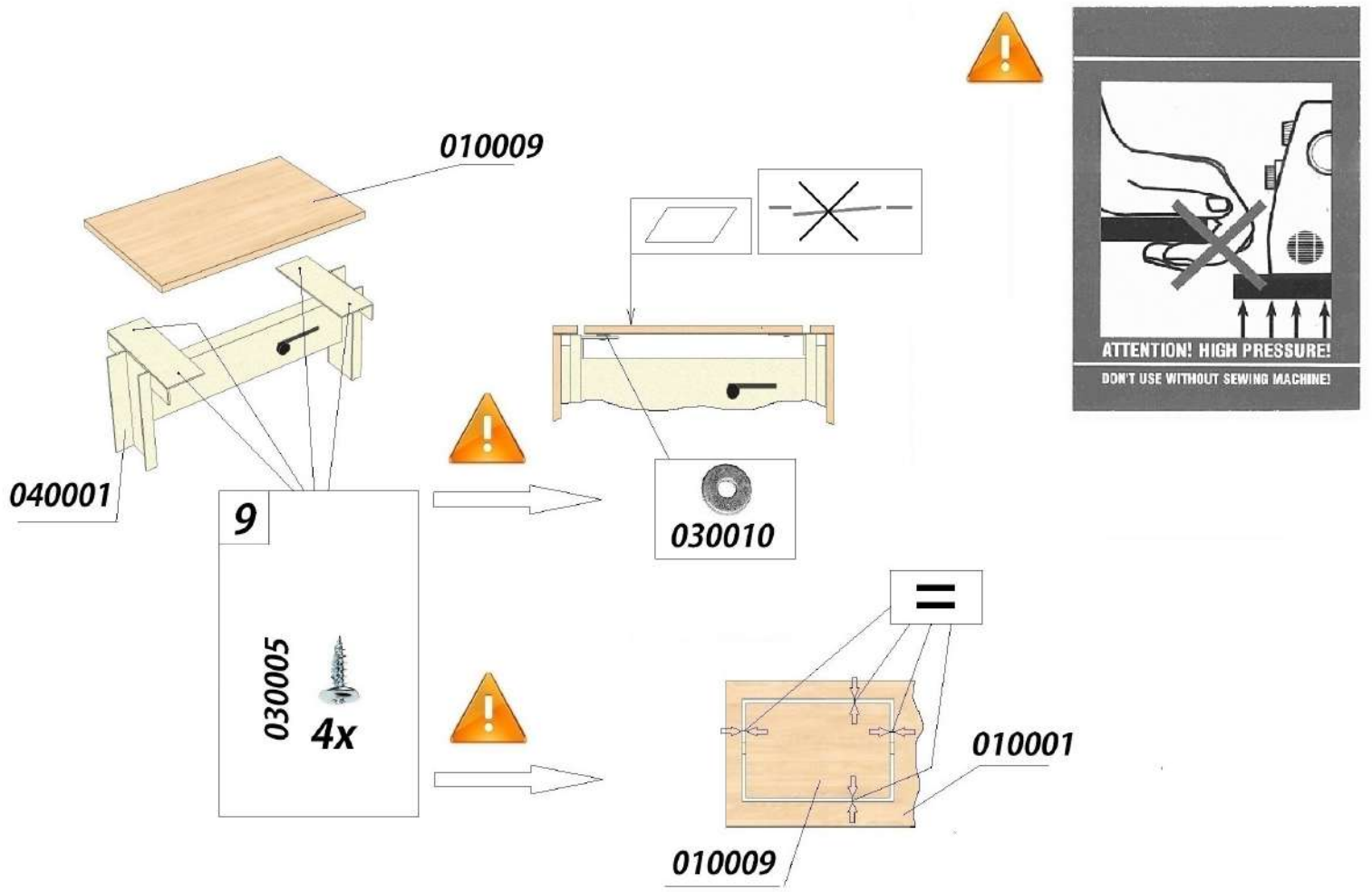

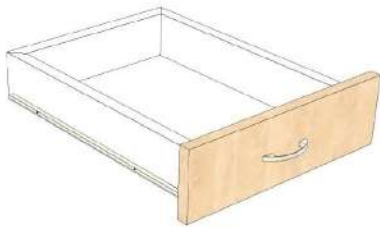

15

2x 030001

1x 020015 DR

12

030016

2x

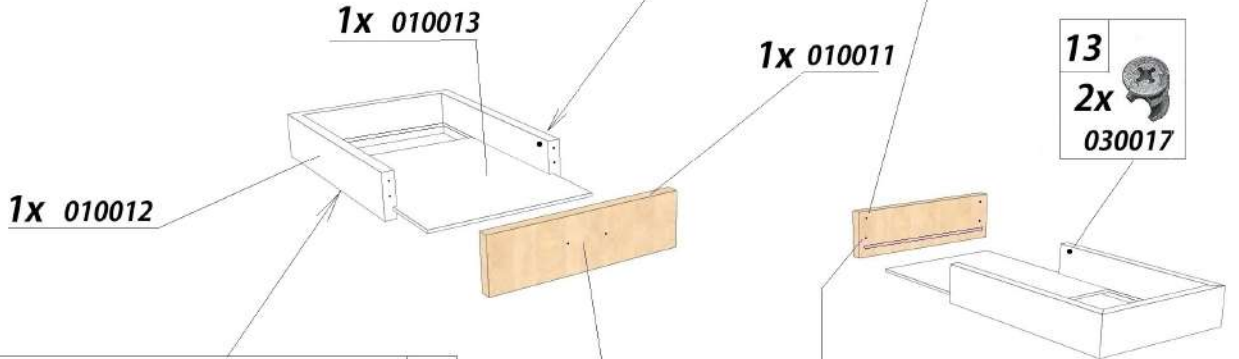

13

2x 030017

15

1x 020015 DL

2x 030001

14

030009 030008

2x 2x

1x 020006

11

030015

2x

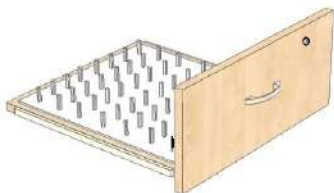

16

030002

4x

1x 050004

20

030001

2x

1x 020015 DR

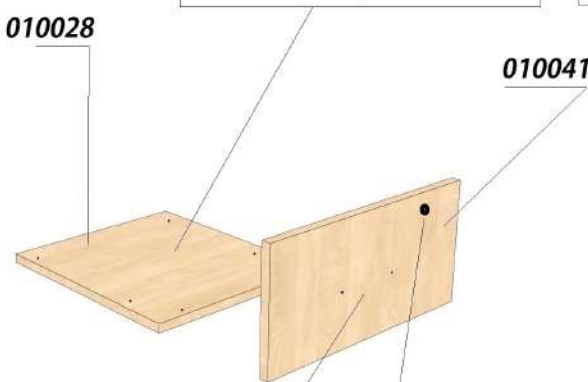

17

030003

2x

18

030027 030008

2x 2x

1x 020006

19

020011

1x

4x 030002

20

030001

2x

1x 020015 DL

