

***KNITTING MACHINE TABLE***  
***COMFORT***

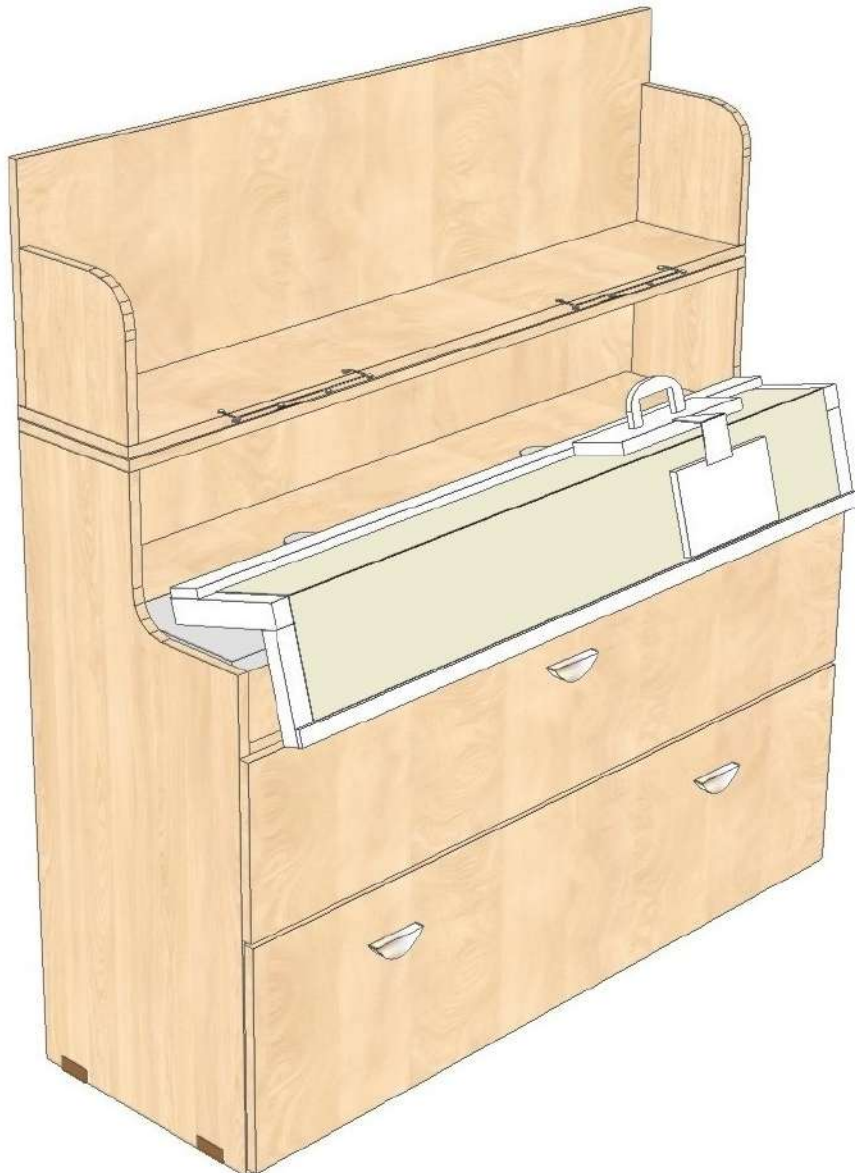

# ***SYMBOLS***



***ATTENTION***



***ASSEMBLY & ADJUSTMENT***



***OPERATION***



***STORAGE***

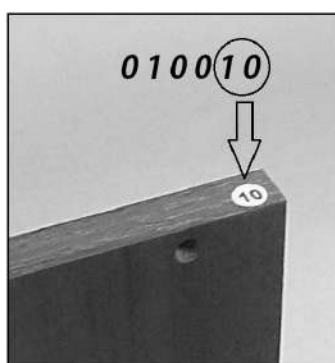

***INDICATING MARK***



***SPECIAL OPERATION***

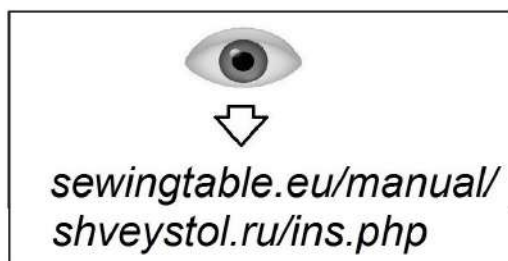

***WATCH***

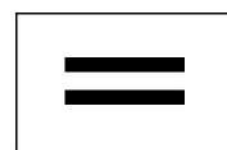



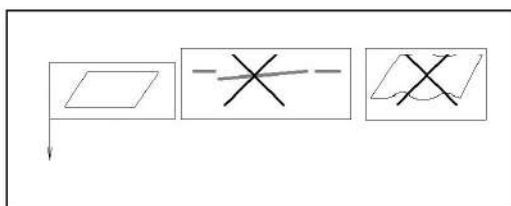

***EQUALITY***



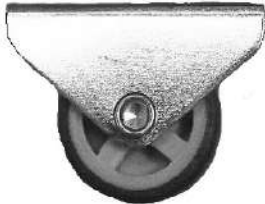

***EVEN SURFACE***



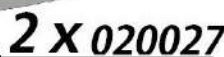









010001 1x	010002 1x	010003 1x	010004 1x
010005 1x	010006 1x	010007 1x	010008 1x
010010 1x	010011 1x	010017 1x	010018 1x
010024 1x	010025 1x	010026 1x	010027 1x
010029 1x	010033 1x	010035 1x	010036 1x

<p>2x 020007</p> 	<p>6x 020023</p> 	<p>4x 020024</p> 
--	--	--

<p>2x 020025</p> 	<p>2x 020026</p> 	<p>2x 020027</p> 
--	---	--

<p>020028</p>  <p>2x</p>	<p>2x 020029</p> 	<p>5x 020031</p> 
--	--	---

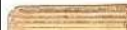
<p>2x 020032</p> 	<p>2x 020030</p> 
--	--

<p>030001</p>  <p>3 * 16</p> <p>4x</p>	<p>030002</p>  <p>3,5 * 16</p> <p>30x</p>	<p>030003</p>  <p>6,2 * 50</p> <p>32x</p>	<p>030033</p>  <p>4,2 * 13</p> <p>20x</p>	<p>030006</p>  <p>2,9 * 13</p> <p>4x</p>	<p>030008</p>  <p>φ4</p> <p>12x</p>	<p>030009</p>  <p>M4 * 20</p> <p>12x</p>
<p>030011</p>  <p>φ15</p> <p>32x</p>	<p>030012</p>  <p>φ18</p> <p>21x</p>	<p>030013</p>  <p>L = 35</p> <p>21x</p>	<p>030014</p>  <p>φ15 h12</p> <p>21x</p>	<p>030015</p>  <p>φ8 * 30</p> <p>12x</p>	<p>030025</p>  <p>M5 * 30</p> <p>8x</p>	<p>030026</p>  <p>8x</p>

<p>2x 040004</p> 
--

<p>2x 050001</p> 
---



S 4 \*

S 10

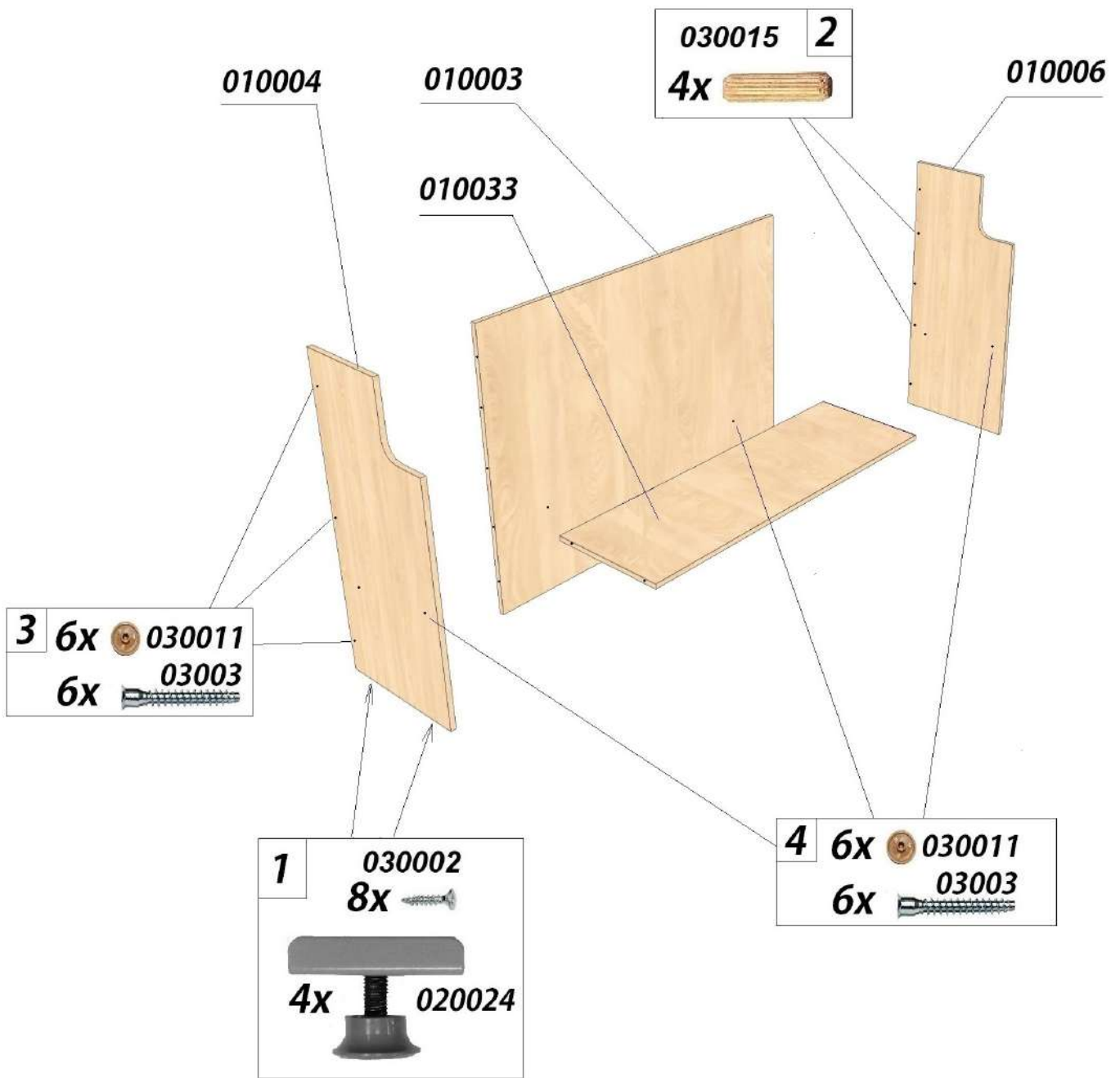

**5** 2x 040004  
2x 020025

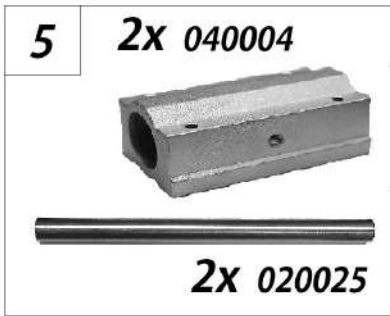

010005  
010017

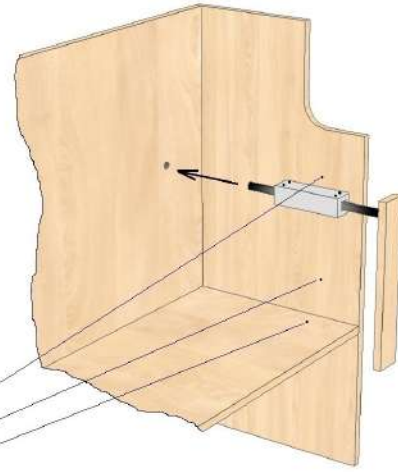
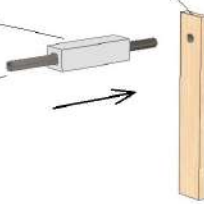

**6** 6x 030011  
6x 03003

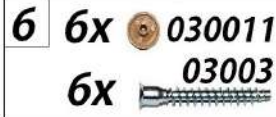

**7** 3x 030011  
3x 03003

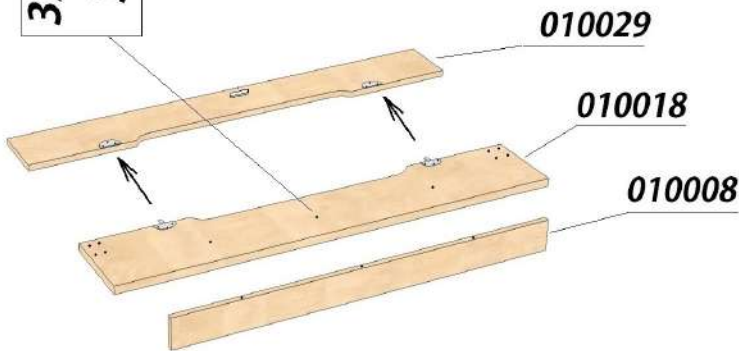
**8** 8x 030025  
**9** 8x 030026

**10** 4x 030002  
2x 020028

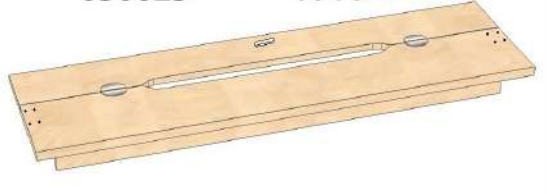

**11** 4x 030006  
2x 020026

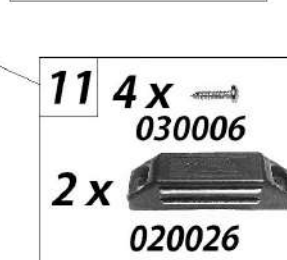

**14** 2x 020030  
8x 030002

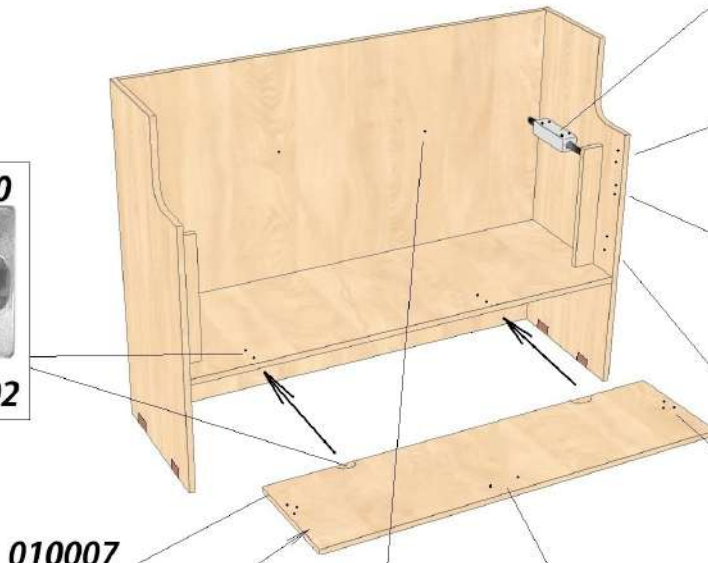
**15** 10x 030002  
2x 020007

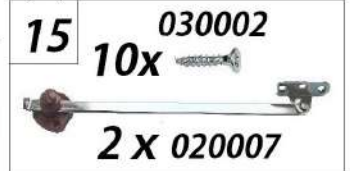

**16** 2x 020027  
4x 030001

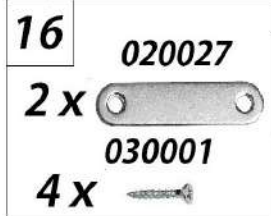

**12** 2x 020029



**13** 2x 030008 2x 030009  
1x 020031



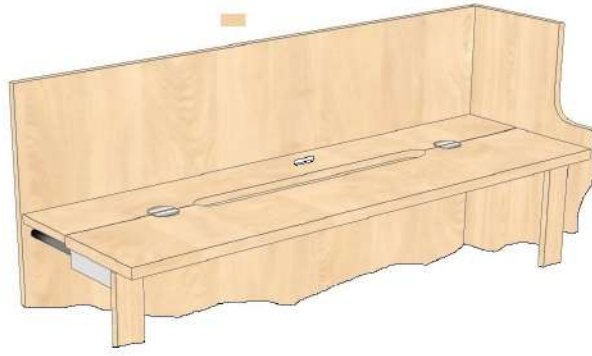

16

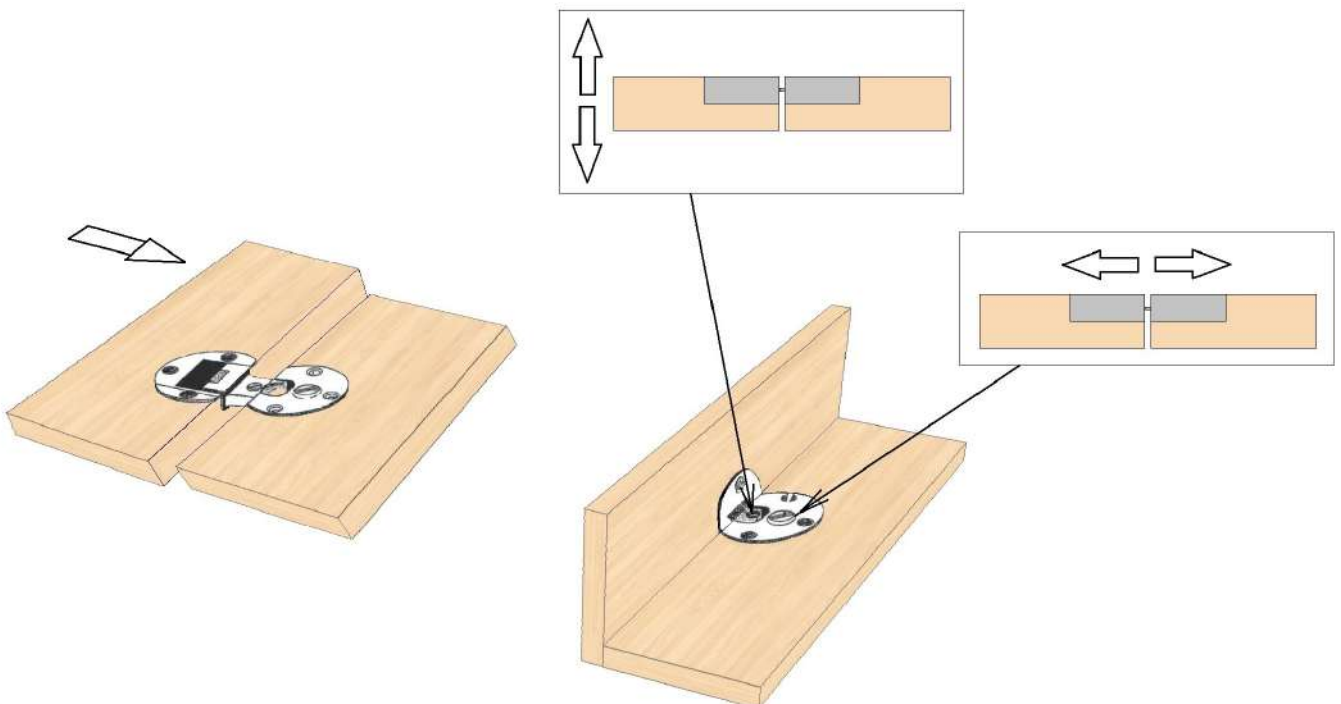
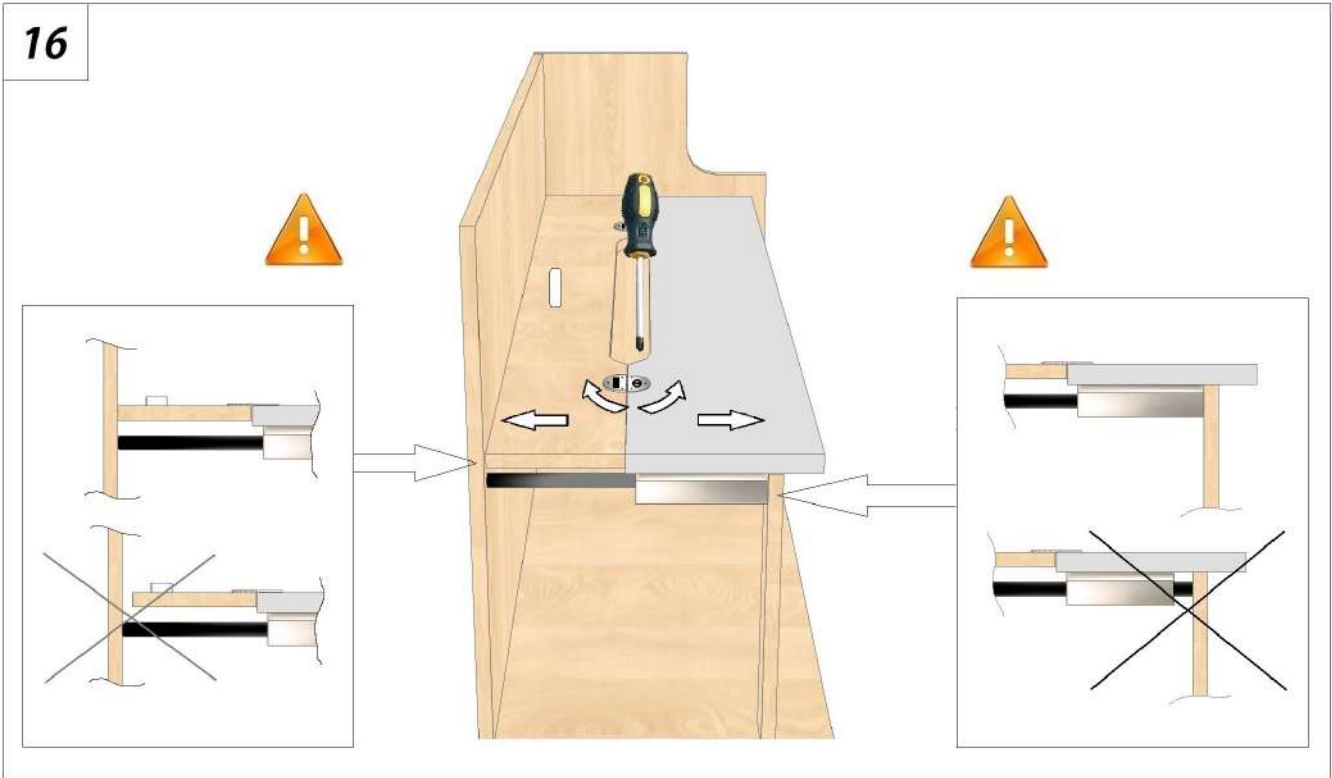

6

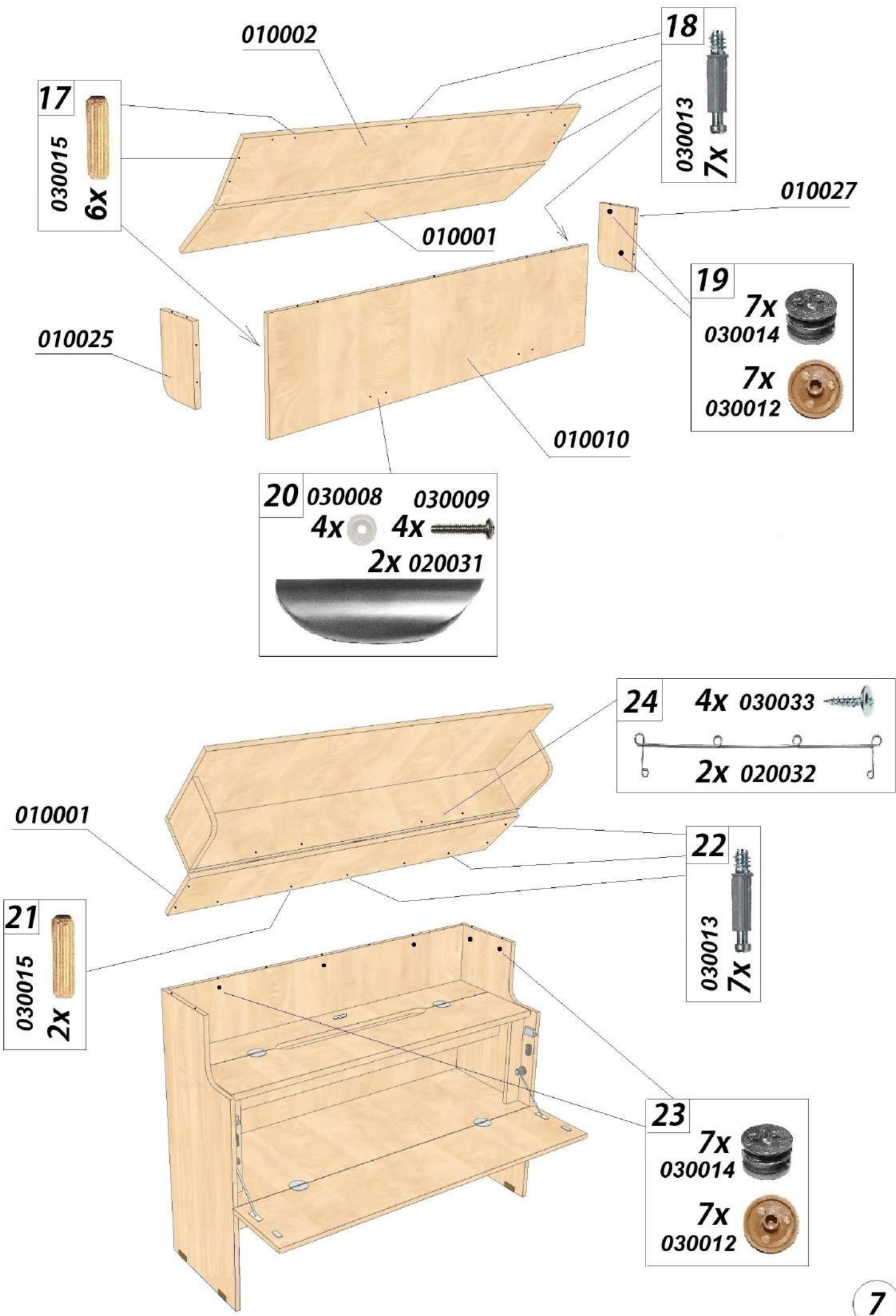



010024

010036



010035

010026

010011

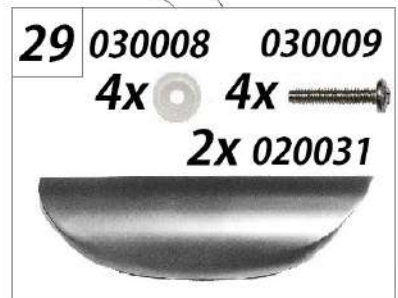



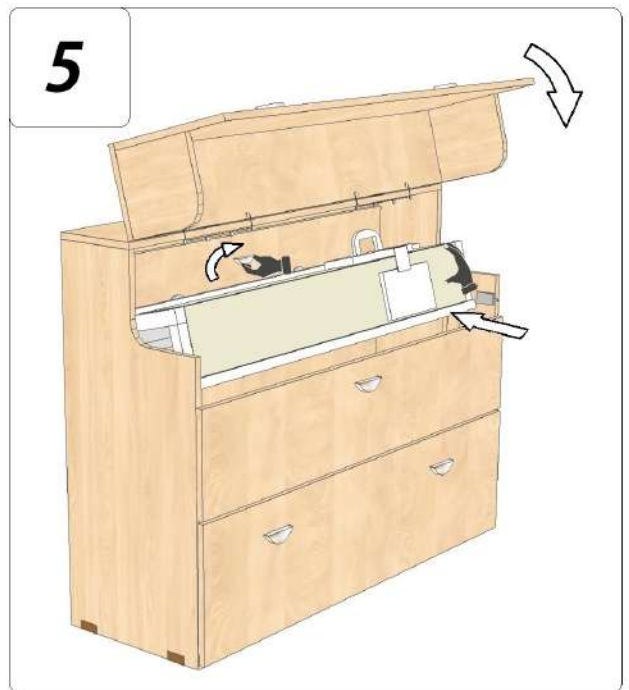
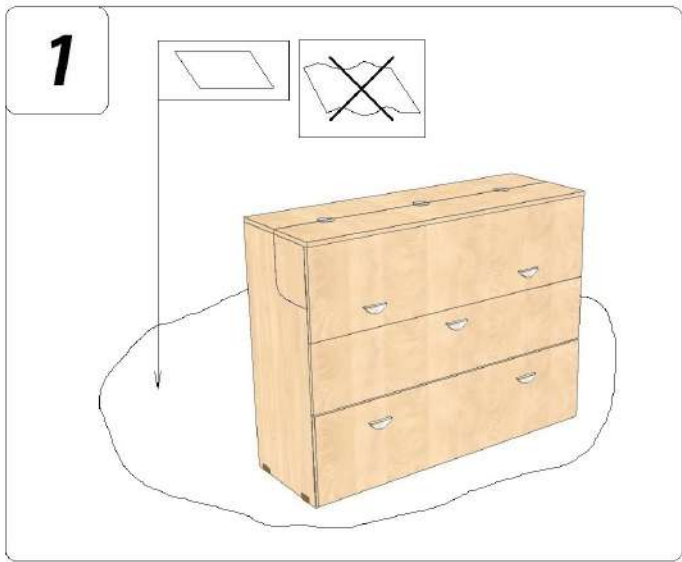
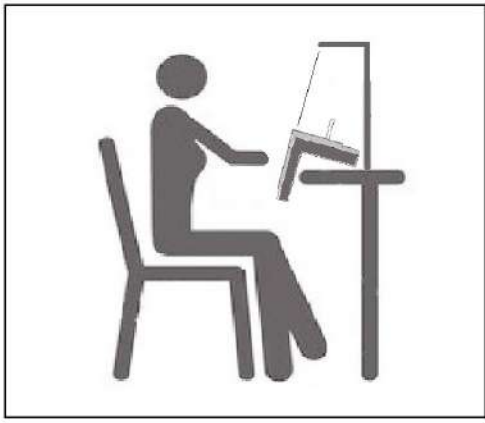

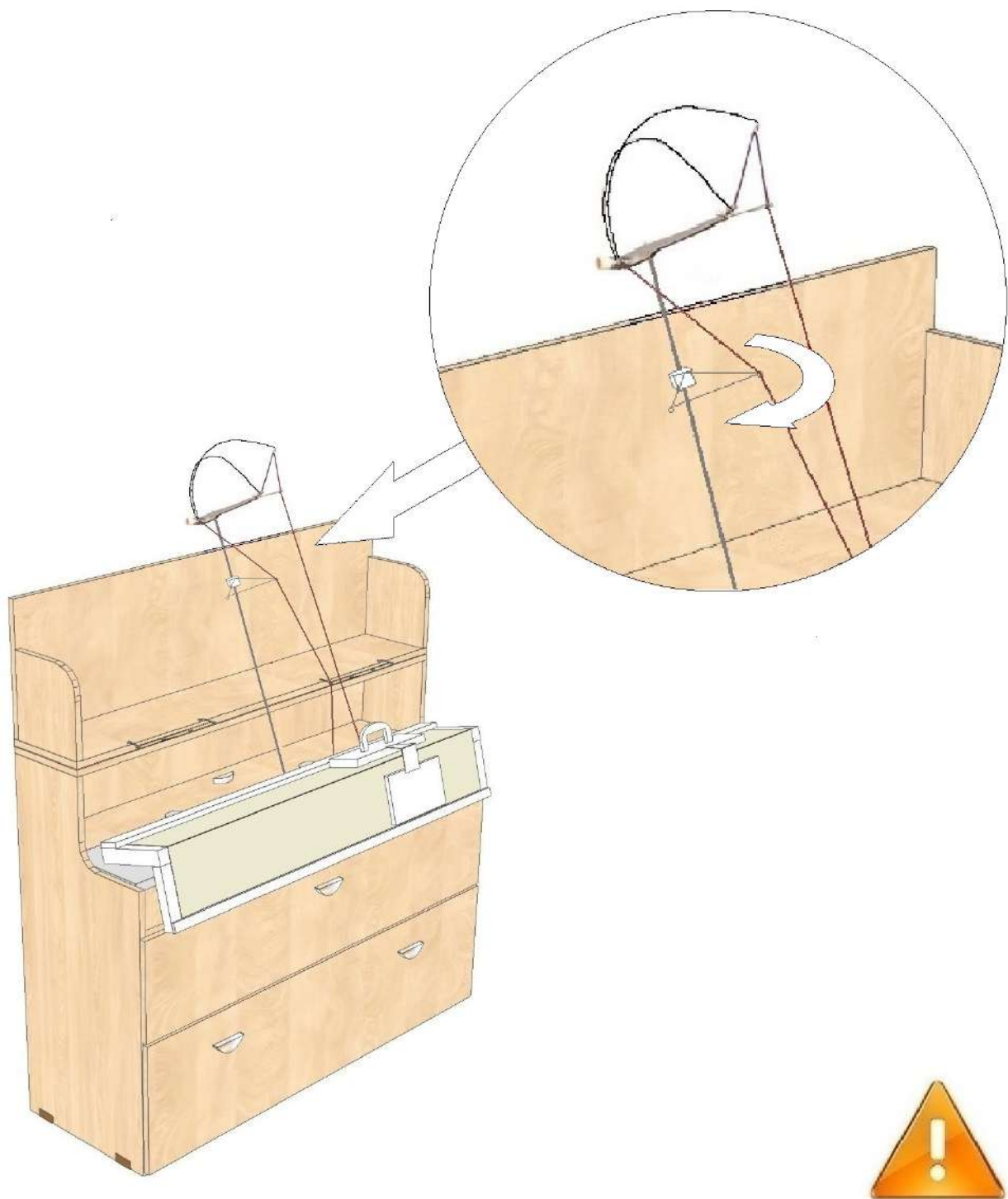





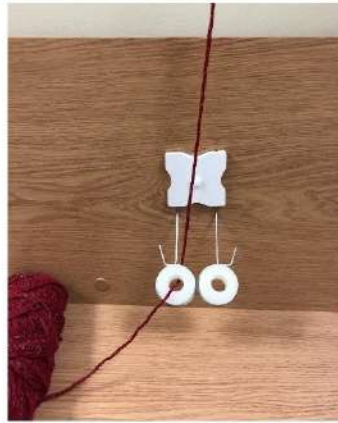

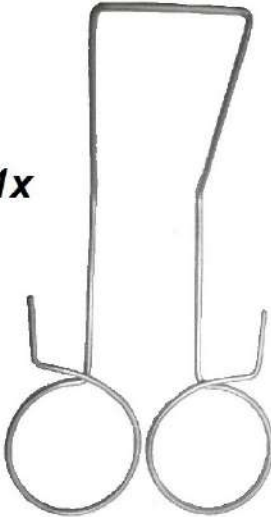
***To ensure normal thread unwinding we recommend the use one of eight thread guide in table surface and thread guide on metal support ( please turn it to find right position.***

# Accessories.Paraffin holder



 <p>1x</p>	 <p>1x</p>	 <p>1x</p>	 <p>2x</p> <p><math>\phi</math> 38</p>
 <p>1x</p>	 <p>1x</p> <p>3,5*19</p>		

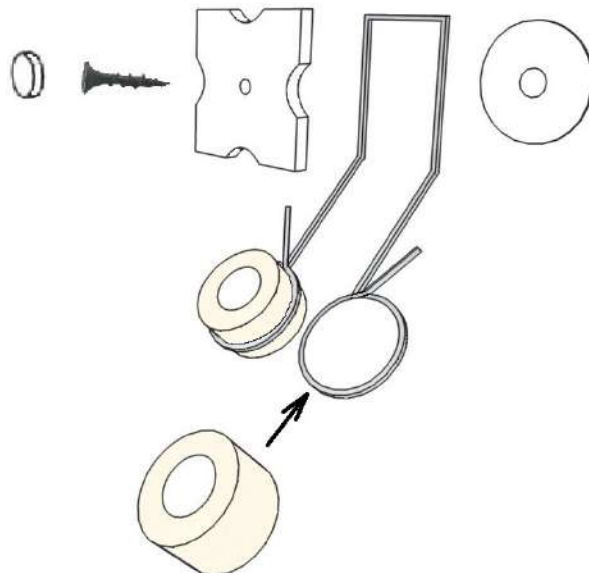

# Accessories.Laptop shelf

